



www.haro.com



DISANO
The Design Floor
for Healthy Living

100 % free
from PVC and
plasticisers



DISANO Classic Aqua
The comfortable design floor for upscale living. also for damp areas.



DISANO Saphir
The hard-wearing design floor for all requirements. water-proof.



DISANO SmartAqua
The smart design floor for young living. also for damp areas.



DISANO Project
The design floor for professional installation. water-proof.



DISANO Life
The smart design floor for young living.

The HARO Price List 2019

- Parquet
- Strip Parquet
- Laminate Floor
- Cork Floor
- Celenio
- Disano
- parkettmanufaktur
- Interior
- Accessories

Further details are available at www.haro.com/at

Hamberger Flooring Austria GmbH
Baumgasse 79, 1030 Wien, Österreich, Telefon +43 1 799 0 333-0, Telefax +43 1 799 0 333-50, E-Mail austria@haro.com
www.haro.com/at

01/19 CEE Subject to errors and modifications. January 2019. MSRP €

HAMBERGER
FLOORING

Welcome to HARO



Company management in the fourth and fifth generations: Peter Hamberger and Dr. Peter M. Hamberger

Our family business has more than 150-years tradition in woodworking. With our love for natural wood and our high quality standards, we have evolved into Germany's leading parquet manufacturer. People in more than 90 countries around the world enjoy our brand name quality flooring. As a family-managed company with a long tradition we are deeply committed to sustainable products and a high level of innovation, which are integral parts of our corporate identity and philosophy. Have a look at our great choice and enjoy selecting your new dream floor.



Sustainability

Hamberger Flooring GmbH & Co. KG has been PEFC-certified since the beginning of 2004. This guarantees that the wood we use is sourced from sustainably managed forests.



HARO Warranty

In addition to the statutory warranty term, HARO also provides additional warranties for various product groups. Please note the respective warranty conditions.



Real Wood

Hamberger Flooring GmbH & Co. KG leads the way in implementing the real wood campaign to ensure real wood floors are correctly identified as such.



Blue Angel Eco Label

The Blue Angel has proven the environmental compatibility of our products since 1992.



ISO 9001

Our quality management system has been certified in accordance with DIN EN ISO 9001: 2000 since 1995. It secures workflows in the company and consequently contributes to maintaining consistent product quality.



Made in Germany

Because our top quality floors are produced with the proverbial German high precision workmanship, they come with the internationally renowned and highly-prized "Made in Germany" label.



ISO 14001

With the certification according to DIN EN ISO 14001: 2004, we have committed ourselves to an active environmental management since 1998.



CE

The CE label confirms that HARO floor coverings comply with all essential European safety and health directives.



ISO 50001

The ISO 50001 standard is aimed at supporting companies in establishing processes and systems necessary to reduce their energy consumption and increase energy efficiency.



EPLF

Hamberger Flooring GmbH & Co. KG is a founder member of the Association of European Producers of Laminate Flooring.



vdp/FEP

Hamberger Flooring GmbH & Co. KG is a member of the Verband der Deutschen Parkettindustrie e.V. (Association of the German Parquet Industry) and of the FEP, the European Federation of the Parquet Industry.



MMFA

Hamberger Flooring GmbH & Co. KG is a founder member of the Multilayer Modular Flooring Association.

Contents



Our family business has an over 150-year tradition in woodworking. Innovations for a beautiful home are thus an integral part of our day-to-day business. In addition to our tried-and-tested floor classics, we offer a range of products that opens up even more possibilities for individual and high-quality room design. These include the particularly broad design of Plank 1-Strip Plaza, the intriguing natural texture of the parquet surfaces, the trendy natural colours, and the revolutionary naturaDur Parquet surface. Laminate Floors, DISANO and Cork Floors impress with what nobody can do better than HARO: Creating surfaces in a strikingly authentic wood look.

Explore the world of naturally beautiful floors, keep up-to-date with the latest trends and find what suits your personal style – at Germany's leading parquet manufacturer.

■ HARO Parquet

■ **HARO PARQUET special topics** 8

Longstrip Series 3500 18

Longstrip Series 4000 20

Plank 1-Strip 3500 Series 26

Plank 1-Strip 4000 Series 28

Plank 1-Strip 4000 Series Plaza 38

parkettmanufaktur by HARO 42

 Plank 1-Strip 44

 Customisation options 46

 Masterpiece 52

 Parquet Tile 56

Strip Parquet 62

 Strip Allegro 62

 Strip Prestige 66

 Strip Plank Scala 68

 Strip Plank Maxim 70

■ HARO Laminate Floor

■ **HARO Laminate Floor special topics** 74

Special Edition NKL 31 84

TRITTY 90 88

TRITTY 100 92

 TRITTY 100 Loft 4V 96

 TRITTY 100 Campus 4V 98

 TRITTY 100 Gran Via 4V 100

TRITTY 200 Aqua 104

 TRITTY 200 Aqua Gran Via 4V 106

■ HARO Cork Floor

■ **HARO Cork Floor** 108

■ DISANO by HARO

■ **DISANO by HARO - The Design Floor for Healthy Living** 112

DISANO Saphir 114

DISANO Classic Aqua 116

DISANO Smart Aqua 120

DISANO Life 124

DISANO Project 126

■ CELENIO by HARO

■ **Celenio by HARO - The Unique Wood Floor** 130

■ HARO Accessories

■ **Interior** 134

Accessories 150



Your direct link to the
HARO website

HARO PARQUET – always the right choice

Look

As Germany's number one parquet manufacturer we offer you a huge selection of premium-quality parquet floors for every taste and every demand – always with classic looks and in-line with the latest trends.

Quality

It is the foundation on which our company and our parquet floors are based. We offer you high quality. Made in Germany is quality you can rely on in your home day after day.

Innovation

The quest for continuous improvement drives our innovations. As a leading parquet manufacturer we are at the forefront of new developments in the industry.

Sustainability

Deeply rooted in the Bavarian Alpine region, our family business has a long tradition of working with the natural raw material wood, which is continued by the fourth and fifth generations. This vast experience and expertise is reflected in every inch of HARO PARQUET.

HARO Quality Parquet offers many advantages to the discerning customer:

- Brand-name quality – Made in Germany
- Germany's leading parquet manufacturer
- More than 150 years experience in the manufacture of wood
- Wood from sustainably managed forests – PEFC certified
- Extensive and appealing product line diversity
- The perfect floor for every taste and every style.
- Hard-wearing, easy-care surfaces with permaDur finish, naturaDur finish or naturaLin *plus* natural oil finish
- Easy to install with Top Connect – also on underfloor heating and cooling
- Resandable
- Warranty up to 30 years

HARO Parquet with three-layer construction

For floating or glue-down installation

Technical construction

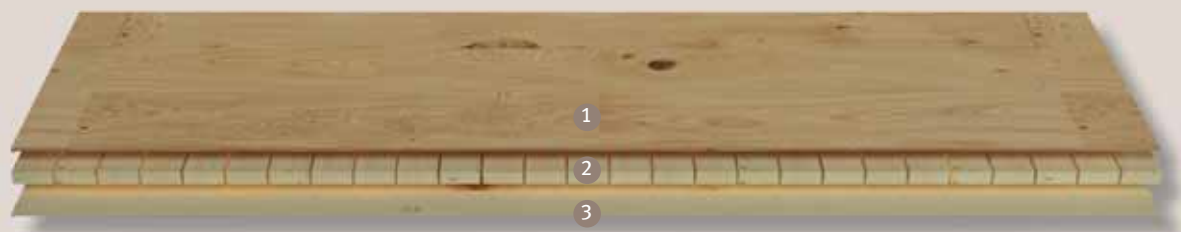

3-layer construction for floating installation, full glue-down installation or installation with self-adhesive ComforTec system

1. Approx. 3.5 mm thick top layer of choice precious wood (by HARO PARKETT 3500 approx. 2.5 mm)
2. Solid spruce fingerstrips as middle layer (HDF E1 middle layer in 3500 series)
3. Softwood backing veneer

Available in the following variants:

LONGSTRIP	Top layer	Total thickness	Surface layer dimensions	Warranty	ComforTec	Silent Pro	Installation system	Can be sanded
3500 Series	approx. 2,5 mm	approx. 12 mm	180 x 2200 mm	15 years	optional	optional	Top Connect	1 x
4000 Series	approx. 3,5 mm	approx. 13,5 mm	180 x 2200 mm	30 years	optional	optional	Top Connect	several times

PLANK 1-STRIP	Top layer	Total thickness	Surface layer dimensions	Warranty	ComforTec	Silent Pro	Installation system	Can be sanded
3500 Series	approx. 2,5 mm	approx. 12 mm	180 x 2200 mm	15 years	optional	optional	Top Connect	1 x
4000 Series	approx. 3,5 mm	approx. 13,5 mm	180 x 2200 mm	30 years	optional	optional	Top Connect	several times
4000 Series *	approx. 3,5 mm	approx. 13,5 mm	173 x 2200 mm	30 years	optional	optional	Top Connect	several times
4000 Series Plaza	approx. 3,5 mm	approx. 13,5 mm	240 x 2200 mm	30 years	optional	optional	Top Connect	several times
4000 Series Plaza **	approx. 3,5 mm	approx. 13,5 mm	220 x 2200 mm	30 years	optional	optional	Top Connect	several times

* Thermo wood, African Oak, Smoked Oak, Ash Fancy

** Smoked Oak

Three different board formats
give you almost unlimited
design possibilities.

Longstrip:

Clear and crisp look provided by three
parallel strips.
Formats: 180 x 2200 mm

Plank 1-Strip:

The modern parquet classic in the plank
design gives a spacious appearance to
the room.
Formats: 180 x 2200 mm respectively
173 x 2200 mm

Plank 1-Strip Plaza:

The extra wide Plank 1-Strip format
creates an impression of generous space
and elegance
Formats: 240 x 2200 mm respectively
220 x 2200 mm



HARO Parquet with two-layer construction

For professional glue-down installation

Technical construction



2-layer construction
for glue-down installation

1. Top layer with a thickness of approx. 3.5 mm, (or approx. 2.5 mm for Strip Allegro 3000), made of carefully selected precious wood
2. Solid spruce fingerstrips or HDF-E1 coreboard as base layer (for Strip Plank 1-Strip Maxim 4000, Strip Allegro 3000)

Available in the following variants:

STRIP ALLEGRO	Top layer	Total thickness	Surface layer dimensions	Warranty	ComforTec	Silent Pro	Installation system	Can be sanded
3000 Series	approx. 2,5 mm	approx. 9 mm	70 x 490 mm	15 years	–	–	Tongue/groove	1 x
Serie 4000	approx. 3,5 mm	approx. 10 mm	70 x 490 mm	30 years	–	–	Tongue/groove	several times
STRIP PRESTIGE	Top layer	Total thickness	Surface layer dimensions	Warranty	ComforTec	Silent Pro	Installation system	Can be sanded
4000 Series	approx. 3,5 mm	approx. 10 mm	120 x 1000 mm	30 years	–	–	Tongue/groove	several times
STRIP PLANK SCALA	Top layer	Total thickness	Surface layer dimensions	Warranty	ComforTec	Silent Pro	Installation system	Can be sanded
4000 Series	approx. 3,5 mm	approx. 10 mm	160 x 1750 mm	30 years	–	–	Tongue/groove	several times
STRIP PLANK MAXIM	Top layer	Total thickness	Surface layer dimensions	Warranty	ComforTec	Silent Pro	Installation system	Can be sanded
4000 Series	approx. 3,5 mm	approx. 10,5 mm	180 x 2200 mm	30 years	–	–	Tongue/groove plus	several times
4000 Series *	approx. 3,5 mm	approx. 10,5 mm	173 x 2200 mm	30 years	–	–	Tongue/groove plus	several times

* Smoked Oak

Classical or contemporary, timeless or trendy – 4 different formats for all tastes.

Strip Plank Maxim:

The strip parquet design in the very trendy original plank 1-strip format.
Formats: 180 x 2200 mm
respectively 173 x 2200 mm

Strip Plank Scala:

Large, elegant strip parquet design – creates a well-balanced, spacious effect
Formats: 160 x 1750 mm

Strip Prestige:

Strip parquet design in compact plank format – also perfect for making small rooms look larger.
Formats: 120 x 1000 mm

Strip Allegro:

Timeless, classic strip parquet design for a wide variety of installation patterns.
Formats: 70 x 490 mm

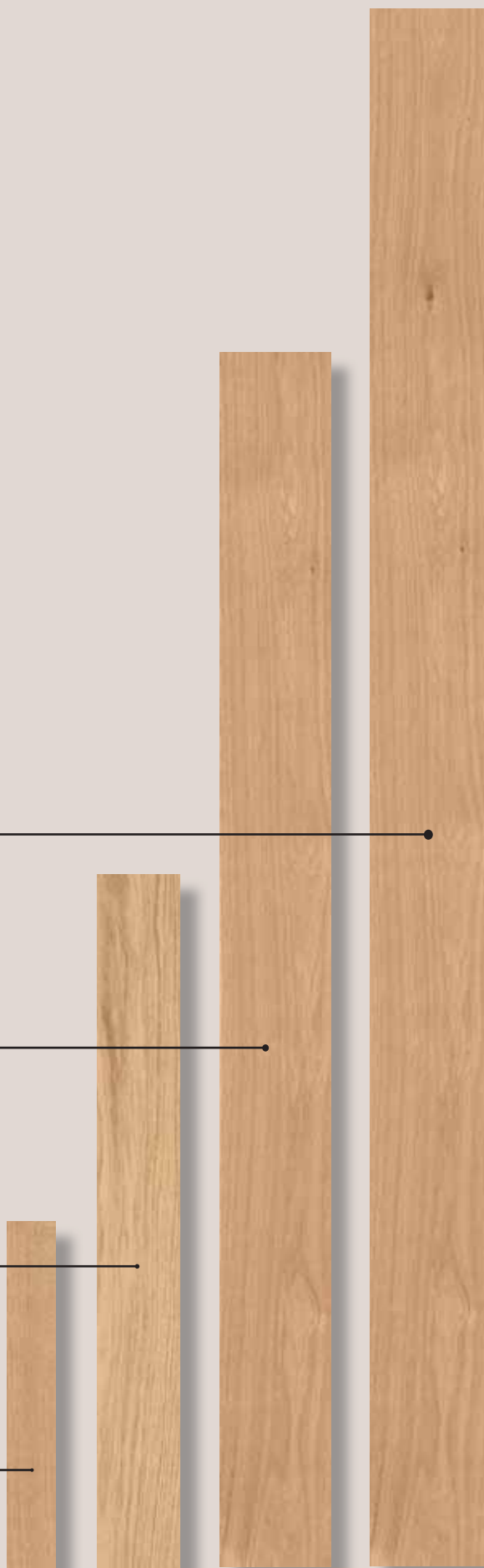

Longstrip / Strip Allegro

The top layers we select for our HARO parquets are available in a wide variety of grades from subtle to vibrant – so you can find exactly the parquet you were looking for. As with all good things in life it is best to judge for yourself what is right for you. The descriptions of the grades can only give you a general idea of their visual effect. Your HARO dealer will be happy to show you how the individual grades differ in their impact.

	Calm/Elegant	Natural	Vibrant
Exquisit	[Progressive bar from Calm/Elegant to Vibrant]		
Trend	[Progressive bar from Calm/Elegant to Vibrant]		
Terra	[Progressive bar from Calm/Elegant to Vibrant]		
Favorit	[Progressive bar from Calm/Elegant to Vibrant]		

HARO PARQUET Longstrip, Strip Allegro



Exquisit ○

- Choice top-layer strips of uniform texture
- Look: Subtle, distinguished, elegant



Trend △

- Natural wood grain with a few small knots
- Look: Natural, classical, timeless



Terra □

- Natural wood grain with a few small knots
- Look: Vibrant, rustic



Favorit □

- Well-balanced combination of subtle and vibrant top layer strips
- Look: Appealing colour differences, varied

Note: With exotic wood, marks that are typical for the type of wood may form (mineral effects).

○, △, □ graded in acc. with EN 13489, 4.4; all others graded in acc. with EN 13489, B

Grades

Plank 1-Strip / Plank 1-Strip Plaza / Strip Prestige / Strip Plank Scala / Strip Plank 1-Strip Maxim

	Calm/Elegant	Natural	Vibrant
Exklusiv	[Progressive bar from Calm/Elegant to Natural]		
Markant	[Progressive bar from Calm/Elegant to Vibrant]		
Sauvage	[Progressive bar from Natural to Vibrant]		
Alabama	[Progressive bar from Natural to Vibrant]		
Universal	[Progressive bar from Calm/Elegant to Vibrant]		

HARO PARQUET Plank 1-Strip, Plank 1-Strip Plaza, Strip Prestige, Strip Plank Scala, Strip Plank Maxim



Exklusiv

- Choice top-layer strips of uniform texture and colour
- Look: Subtle, distinguished, elegant



Markant

- Varies wood grain with natural amount of knots
- Look: Natural, classical, timeless



Sauvage

- Natural to vibrant wood texture with a larger dark-filled knots
- Cracks, filled points and worm holes possible
- Look: Trendy, rustic



Alabama

- Lively wood texture with authentic larger number of knots and a number of black puttied cracks
- Look: Individual, rustic, authentic



Universal

- Combination of our grades, including heartwood
- Look: Vibrant



permaDur

HIGH FINISH

The hard-wearing finish

PERFECT FOR,
anyone who is looking for a particularly durable parquet floor that is easy to maintain.

CARE

- Dry cleaning with broom or vacuum cleaner.
- Damp cleaning with clean & green natural when required.
- Renewal with clean & green Aqua shield, if necessary (Changes in the gloss level may occur).

naturaDur

MATT SURFACE FINISH

The natural matt surface finish with the best possible protection

PERFECT FOR,
those who want the look of a natural oil surface in combination with the perfect protection and safety of a pre-finished floor that is easy to maintain.

CARE

- Dry cleaning with broom or vacuum cleaner.
- Damp cleaning with clean & green natural when required.
- Renewal with clean & green Aqua shield, if necessary (Changes in the gloss level may occur).

naturaLin^{plus}

NATURAL OIL FINISH

Breathable natural oil surface

PERFECT FOR,
looking for a very expressive and natural parquet floor.

CARE

- Dry cleaning with broom or vacuum cleaner.
- Regular damp cleaning with naturaLin Soap or clean & green natural protects against dirt, wear and tear.
- Regular renewal of the surface finish with naturaLin Oil or Clean & Green Aqua Oil after heavy wear and tear (Changes in the gloss level may occur).

Surface textures

SMOOTH

- Perceptibly natural texture
- Velvety-matt surface
- Timeless beauty



BRUSHED

- Authentic feel and very natural look of the surface
- Trendy
- By treating the surface with special brushes, the soft material between the annual rings is brushed down.



ALPINE BRUSHED

- Authentic feel and very natural look of the surface
- Rustic, distinctive texture
- Exclusively for HARO PARQUET Plank 1-Strip Plaza



RETRO BRUSHED/ RETRO BRUSHED 3D

- Authentic texture that reflects the natural growth of the wood and emphasises the knots.
- In combination with the matt natural oil finish, the floor looks all natural yet very modern.
- For the RETRO BRUSHED 3D surface finish, the bevelled edges on all four sides are additionally attached to each strip of the Longstrip boards. This gives each single strip the character of a parquet strip.



PATENTED
PROCEDURE

Installation

Installation system

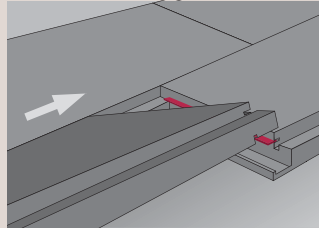

Angle in

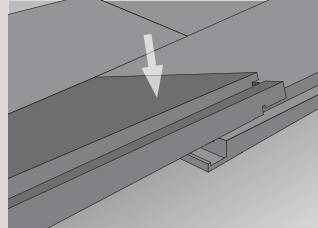

Press down

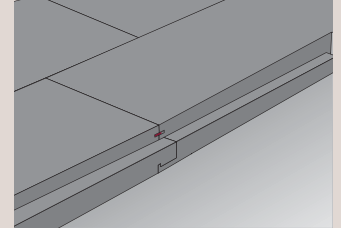

Finished

Top Connect is one of the world's easiest installation systems. The boards are angled in at the long sides and interlocked at the short sides with a small amount of pressure. The floor is not only easy to put in, it is just as easy to take out when you move.

- No tools required
- Very quick to install
- High-precision system
- Easy to put in – easy to take out
- Safe and secure connections on the short and long sides
- Also suitable for glue-down installation



5G Fold Down locking system

Installation system with ComforTec



5G Fold Down locking system

ComforTec

	Glue-down installation	ComforTec	Floating installation
Indoor sound	+++	+++	•
Walking comfort	+++	+++	•
Installation without reducer or transition mouldings	+++	+++	•
Ready to "live on" immediately	•	+++	+++
Unpleasant odours/fumes	•	+++	+++
Quick, easy and clean installation	•	+++	+++

+++ excellent • satisfactory depending on adhesive type

Installing high-quality parquet has never been this quick and easy. Our innovative Top Connect lock-in installation system makes it possible. In combination with the self-adhesive ComforTec boards, this system enables you to install your floor like professionals do – but without any tools and with lots of fun.

- The highest level of installation quality in combination with the fastest possible installation system.
- Ready to "live on" immediately
- No glue, no harmful substances
- Walk with the pleasant acoustic of a full glue-down floor
- Suitable for use with underfloor heating and cooling.
- Seamless appearance without the need for end or transition mouldings
- Extensive range with the most popular types of wood
- Available for Longstrip, Plank 1-Strip and Plank 1-Strip Plaza



Insulation layer / Care

Silent Pro insulation layer



Hard floor coverings are not normally associated with comfort. But HARO floors with Silent Pro insulation underlay are kind to the ears, joints and spine. Thanks to the high elasticity provided by the mineral fillers, it creates a pleasant “forest floor effect” and minimises footfall and room sound. Silent Pro is particularly efficient when factory-bonded to the underside of the board. The permanent connection between parquet board and insulation prevents the formation of gaps or voids which would reduce the insulating effect.

Pleasant for you when the sound level in the room is perceptibly minimised.

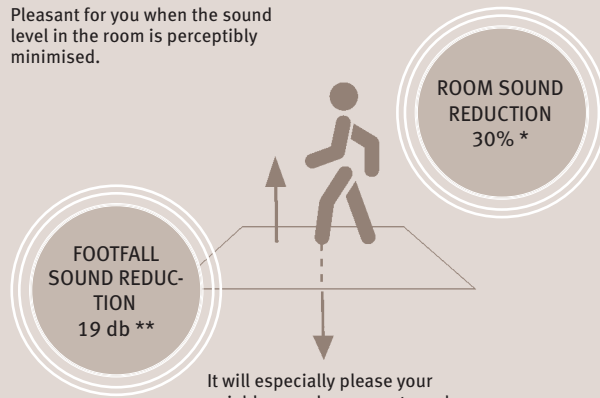

* Maximum individual values achieved in accordance with the EPLF Impact Hammer test (compared to reference floor)
 ** According to DIN 140-8

- Excellent insulation against footfall and room sound
- Reduces strain on body joints and spine
- Available factory-bonded to the underside of the board for installation and insulation in a single work step (minimum quantity 10 m²)
- Suitable for installation on underfloor heating and cooling
- Easy and clean to cut
- Environmentally safe disposal of cuttings in domestic waste



Parquet care with clean & green: Quick, easy and natural

HARO PARQUET is very easy to maintain. With clean & green we offer a specially developed cleaning and care series that is perfectly matched to all our floors and ensures that you can enjoy your branded parquet for a very long time. For more information about cleaning and care see page 192.



www.blauer-engel.de/uz12a

clean & green®
 Quick, easy and natural maintenance of all floors

Longstrip Series 3500

The HARO brand floor at an attractive price

180 x 2200 mm



- 3 offset parallel strips arranged in a regular pattern
- Lively and modern look
- Can be sanded
- Moisture-control HDF E1 middle layer
- Suitable for use with underfloor heating and cooling
- With Top Connect, one of the world's fastest installation systems; easy to install with no tools required

HARO PARQUET 3500 LONGSTRIP

Top layer thickness: approx. 2.5 mm
Surface layer dimensions: 180 x 2200 mm
Overall thickness: approx. 12 mm

Surface:

P_m permaDur

n+ naturaLin plus



HARO PARQUET 3500
Longstrip
OAK
FAVORIT
brushed









Dimensions: 12 x 180 x 2200 mm
 Top layer thickness: approx. 2.5 mm
 Packaging: 6 piece/pack = 2,38 m²
 32 pack/pallet = 76,16 m²
 9,87 kg/m²; 23,49 kg/pack;
 751,68 kg/pallet
 3-layer construction with special moisture-control
 HDF E1 middle layer

LONGSTRIP

PARQUET

3500 Series

From 10 m² all articles on this page optionally available with ComforTec or Silent Pro (delivery time on inquiry).

Wood Species/Grade	Finish	ID N°	
 OAK ⁹ Light White Favorit brushed Matching skirting ID N° 409 614	<u>P_m</u>	534 587	see separate price sheet
 OAK ⁹ Favorit Matching skirting ID N° 406 922	<u>P_m</u>	534 588	see separate price sheet
 OAK ⁹ Favorit brushed Matching skirting ID N° 409 612	<u>n+</u>	534 589	see separate price sheet
 BEECH STEAMED ⁹ Favorit Matching skirting ID N° 406 923	<u>P_m</u>	534 590	see separate price sheet
 SYCAMORE ⁹ Favorit Matching skirting ID N° 406 925	<u>P_m</u>	534 591	see separate price sheet
 WALNUT ⁹ Favorit Matching skirting ID N° 406 931	<u>P_m</u>	534 593	see separate price sheet

LONGSTRIP

Longstrip 4000 Series

The versatile HARO premium floor

180 x 2200 mm



- 3 offset parallel strips arranged in a regular pattern
- Lively and modern look
- Resandable
- Solid wood strip middle layer made of spruce
- Suitable for use with underfloor heating and cooling
- With Top Connect, one of the world's fastest installation systems; easy to install with no tools required

HARO PARQUET 4000 Longstrip

Top layer thickness: approx. 3.5 mm
Dimensions: 180 x 2200 mm
Total thickness according to the series and the fitting: up to 15.6 mm

Surface:

P_m permaDur

n_D naturaDur

n₊ naturaLin plus



HARO PARQUET 4000
Longstrip
ASH SAND WHITE
FAVORIT
brushed



Dimensions: 13.5 x 180 x 2200 mm
 Top layer thickness: approx. 3.5 mm
 Packaging: 8 piece/pack = 3,17 m²
 32 pack/pallet = 101,44 m²
 7,41 kg/m²; 23,49 kg/pack;
 751,68 kg/pallet

3-layer construction with solid wood strip middle layer











LONGSTRIP

PARQUET

4000 Series

From 10 m² all articles on this page optionally available with ComforTec or Silent Pro (delivery time on inquiry).

LONGSTRIP

Wood Species/Grade		Finish	ID N°
	OAK⁹ Light White Favorit brushed	<u>P_m</u>	531 987
	Matching skirting ID N° 409 614		
NEW 	OAK⁹ Sand White Favorit brushed	<u>nD</u> <u>n+</u>	538 923 538 924
	Matching skirting ID N° 409 789		
	OAK Puro White Exquisit brushed	<u>n+</u>	531 686
	Matching skirting ID N° 409 613		
	OAK Puro White Trend brushed	<u>n+</u>	533 343
	Matching skirting ID N° 409 613		
	OAK⁹ Puro White Favorit brushed	<u>P_m</u> <u>nD</u>	538 958 538 957
	Matching skirting ID N° Pm 410 724/nD/n+ 409 613	<u>n+</u>	530 139
	OAK¹⁰ Puro White Terra retro brushed 3D 4V	<u>n+</u>	532 980
	Matching skirting ID N° 409 613		
NEW 	OAK⁹ Invisible Favorit brushed	<u>P_m</u> <u>nD</u>	538 925 538 926
	Matching skirting ID N° Pm 410 725/nD/n+ 409 733	<u>n+</u>	538 927
	OAK Exquisit	<u>P_m</u>	524 689
	Matching skirting ID N° 406 922		
	OAK Exquisit brushed	<u>n+</u>	531 683
	Matching skirting ID N° 409 612		
	OAK Trend	<u>P_m</u>	523 785
	Matching skirting ID N° 406 922		

Only delivered in complete cartons. HARO PARQUET with unfinished/sanded surface available on request; minimum purchasing quantity 200 sq.m. We reserve the right to supply one layer per carton in lengths below 2 m.

¹⁰ Initial treatment with aqua oil required following installation. ⁹ Seasonal variations in grading possible.

Dimensions: 13.5 x 180 x 2200 mm
 Top layer thickness: approx. 3.5 mm
 Packaging: 8 piece/pack = 3,17 m²
 32 pack/pallet = 101,44 m²
 7,41 kg/m²; 23,49 kg/pack;
 751,68 kg/pallet
 3-layer construction with solid wood strip middle layer



From 10 m² all articles on this page optionally available with ComforTec or Silent Pro (delivery time on inquiry).

Wood Species/Grade		Finish	ID N°
	OAK Trend brushed	<u>P_m</u>	524 632
		<u>nD</u>	535 416
	Matching skirting ID N° Pm 409 616/nD/n+ 409 612	<u>n+</u>	530 135
NEW	OAK⁹ Favorit brushed	<u>P_m</u>	538 928
	Matching skirting ID N° 409 616		
	OAK Terra	<u>P_m</u>	523 787
	Matching skirting ID N° 406 922		
	OAK Terra brushed	<u>n+</u>	530 137
	Matching skirting ID N° 409 612		
	OAK¹⁰ Terra retro brushed 3D 4V	<u>n+</u>	532 978
	Matching skirting ID N° 409 612		
	OAK¹⁰ Tobacco Grey Terra retro brushed 3D 4V	<u>n+</u>	532 982
	Matching skirting ID N° 408 680		
NEW	OAK⁹ Sand Grey Favorit brushed	<u>P_m</u>	538 929
		<u>nD</u>	538 930
	Matching skirting ID N° Pm 410 726/nD/n+ 409 785	<u>n+</u>	538 931
	SMOKED OAK Trend	<u>P_m</u>	524 836
	Matching skirting ID N° 406 932		
	SMOKED OAK Trend brushed	<u>nD</u>	535 417
	Matching skirting ID N° 409 611		
	SMOKED OAK²⁹ Favorit	<u>P_m</u>	533 197
	Matching skirting ID N° 406 932		



Dimensions: 13.5 x 180 x 2200 mm
 Top layer thickness: approx. 3.5 mm
 Packaging: 8 piece/pack = 3,17 m²
 32 pack/pallet = 101,44 m²
 7,41 kg/m²; 23,49 kg/pack;
 751,68 kg/pallet

3-layer construction with solid wood strip middle layer











LONGSTRIP

PARQUET

4000 Series

From 10 m² all articles on this page optionally available with ComforTec or Silent Pro (delivery time on inquiry).
 Supplement excl. VAT 8,25 €

all prices in € /m²

Wood Species/Grade	Finish	ID N°	excl. VAT
 SMOKED OAK ^{2,9} Favorit brushed Matching skirting ID N° 409 611	<u>n+</u>	535 652	€ 49,92
 AFRICAN OAK Trend Matching skirting ID N° 406 933	<u>P_m</u>	523 813	€ 60,75
 AFRICAN OAK Trend brushed Matching skirting ID N° 409 610	<u>n+</u>	530 141	€ 64,92
 AFRICAN OAK ⁹ Favorit Matching skirting ID N° 406 933	<u>P_m</u>	538 932	€ 52,42
 BEECH STEAMED Trend Matching skirting ID N° P _m 406 923/nD 406 891	<u>P_m</u> <u>nD</u>	523 789 535 419	€ 41,58 € 45,75
 BEECH STEAMED ⁹ Favorit Matching skirting ID N° 406 923	<u>P_m</u>	523 791	€ 35,75
 BEECH STEAMED ⁹ Favorit brushed Matching skirting ID N° 409 786	<u>n+</u>	535 563	€ 38,25
 ASH ⁹ Light White Favorit brushed Matching skirting ID N° 409 045	<u>P_m</u>	531 988	€ 44,92
 ASH ⁹ Sand White Favorit brushed Matching skirting ID N° 409 789	<u>nD</u>	538 933	€ 48,25
 ASH Trend Matching skirting ID N° 406 926	<u>P_m</u>	524 642	€ 49,92

LONGSTRIP

Only delivered in complete cartons. HARO PARQUET with unfinished/sanded surface available on request; minimum purchasing quantity 200 sq.m.











We reserve the right to supply one layer per carton in lengths below 2 m.

² Delivery time on inquiry ⁹ Seasonal variations in grading possible.

Dimensions: 13.5 x 180 x 2200 mm
 Top layer thickness: approx. 3.5 mm
 Packaging: 8 piece/pack = 3,17 m²
 32 pack/pallet = 101,44 m²
 7,41 kg/m²; 23,49 kg/pack;
 751,68 kg/pallet
 3-layer construction with solid wood strip middle layer



From 10 m² all articles on this page optionally available with ComforTec or Silent Pro (delivery time on inquiry).

Wood Species/Grade		Finish	ID N°
	ASH⁹ Favorit	<u>Pm</u>	525 127
	Matching skirting ID N° 406 926		
	CANADIAN MAPLE Trend	<u>Pm</u>	523 809
	Matching skirting ID N° 406 925		
	CANADIAN MAPLE^{3 9} Favorit	<u>Pm</u>	524 406
	Matching skirting ID N° 406 925		
	AMERICAN CHERRY² Trend	<u>Pm</u>	523 811
	Matching skirting ID N° 406 928		
	AMERICAN CHERRY^{2 9} Favorit	<u>Pm</u>	524 442
	Matching skirting ID N° 406 928		
	AMERICAN WALNUT Trend	<u>Pm</u>	523 812
	Matching skirting ID N° Pm 406 931/n+ 406 896	<u>n+</u>	533 046
	AMERICAN WALNUT⁹ Favorit	<u>Pm</u>	524 444
	Matching skirting ID N° Pm 406 931/nD 406 896	<u>nD</u>	535 421
	AMBER ROBINIA⁹ Favorit	<u>Pm</u>	535 566
	Matching skirting ID N° 406 937		
	MERBAU^{13 9} Favorit	<u>Pm</u>	525 190
	Matching skirting ID N° 406 930		
	WENGE^{13 9} Favorit	<u>n+</u>	535 575
	Matching skirting ID N° 406 906		

Only delivered in complete cartons. HARO PARQUET with unfinished/sanded surface available on request; minimum purchasing quantity 200 sq.m.

We reserve the right to supply one layer per carton in lengths below 2 m.

³ while stocks last ¹ See note on exotic woods on page 12 ⁹ Seasonal variations in grading possible.

² Cherry: Dimensions: 13.5 x 180 x 2200 mm, Packaging: 8 piece/pack = 3,17 m² 32 pack/pallet = 101,44 m² 7,1 kg/m²; 22,51 kg/pack; 720,32 kg/pallet

³ Merbau/Wenge: Dimensions: 13.5 x 180 x 2200 mm, Packaging: 8 piece/pack = 3,17 m² 32 pack/pallet = 101,44 m² 8,02 kg/m²; 25,42 kg/pack; 813,44 kg/pallet



HARO PARQUET 4000
Longstrip
OAK
TREND
brushed

Plank 1-Strip 3500 Series

The HARO brand floor at an attractive price

180 x 2200 mm



- One continuous top layer
- Awards the room a very spacious visual impact.
- Can be sanded
- Moisture-control HDF E1 middle layer
- Suitable for use with underfloor heating and cooling
- With Top Connect, one of the world's fastest installation systems; easy to install with no tools required

HARO PARQUET 3500 Plank 1-Strip

Top layer thickness: approx. 2.5 mm
Surface layer dimensions: 180 x 2200 mm
Overall thickness: approx. 12 mm

Surface:

Pm permaDur

n+ naturaLin plus



**Fold Down
locking system**



HARO PARQUET 3500
Plank 1-Strip 2V
OAK PURO WHITE
ALABAMA
brushed



Dimensions: 12 x 180 x 2200 mm
 Top layer thickness: approx. 2.5 mm
 Packaging: 6 piece/pack = 2,38 m²
 32 pack/pallet = 76,16 m²
 9,87 kg/m²; 23,49 kg/pack;
 751,68 kg/pallet







3-layer construction with special moisture-control
 HDF E1 middle layer

PLANK 1-STRIP

PARQUET

3500 Series

From 10 m² all articles on this page optionally available with ComforTec or Silent Pro (delivery time on inquiry).

Wood Species/Grade		Finish	ID N°	incl. VAT
	OAK⁵ Light White Universal brushed 2V	P_m	534 603	see separate price sheet
	Matching skirting ID N° 409 614			
	OAK⁵ Puro White Universal brushed 2V	n₊	534 604	see separate price sheet
	Matching skirting ID N° 409 613			
	OAK Puro White Alabama brushed 2V	n₊	537 348	see separate price sheet
	Matching skirting ID N° 409 613			
	OAK⁵ Universal brushed 2V	P_m n₊	534 605 534 607	see separate price sheet
	Matching skirting ID N° Pm 409 616/n+ 409 612			
	OAK Alabama brushed 2V	n₊	537 349	see separate price sheet
	Matching skirting ID N° 409 612			
	OAK⁵ Nutmeg Brown Universal brushed 2V	n₊	534 608	see separate price sheet
	Matching skirting ID N° 409 723			
	OAK⁵ Velvet Brown Universal brushed 2V	n₊	534 609	see separate price sheet
	Matching skirting ID N° 409 703			

PLANK 1-STRIP

Plank 1-Strip 4000 Series

The versatile HARO premium floor

180 x 2200 mm



- One continuous top layer
- Awards the room a very spacious visual impact.
- Resandable
- Solid wood strip middle layer made of spruce
- Suitable for use with underfloor heating and cooling
- With Top Connect, one of the world's fastest installation systems; easy to install with no tools required

HARO PARQUET 4000 Plank 1-Strip

Top layer thickness: approx. 3.5 mm
 Surface layer dimensions: 180 x 2200 mm
 Exception: Smoked Oak, African Oak, thermo wood and Ash Fancy 173 x 2200 mm).
 Overall thickness: approx. 13.5 mm



5G Fold Down locking system

Surface:

Pm permaDur

nD naturaDur

n+ naturaLin plus

r unfinished

oleovera













HARO PARQUET 4000
 Plank 1-Strip 4V
OAK ATELIER
SAUVAGE
 Retro brushed



Dimensions: 13.5 x 180 x 2200 mm
 Top layer thickness: approx. 3.5 mm
 Packaging: 8 piece/pack = 3,17 m²
 32 pack/pallet = 101,44 m²
 7,41 kg/m²; 23,49 kg/pack;
 751,68 kg/pallet

3-layer construction with solid wood strip middle layer

From 10 m² all articles on this page optionally available with ComforTec or Silent Pro (delivery time on inquiry).

Wood Species/Grade	Finish	ID N°
 NEW OAK Crystal White Markant Matching skirting ID N° 410 707	<u>n+</u>	538 934
 NEW OAK ⁵ Crystal White Sauvage Matching skirting ID N° 410 707	<u>n+</u>	538 935
 OAK Light White Markant brushed 2V Matching skirting ID N° 409 614	<u>P_m</u>	531 216
 OAK Sand White Markant brushed 2V Matching skirting ID N° 409 789	<u>nD</u>	535 443
 NEW OAK Sand White Markant brushed 4V Matching skirting ID N° 409 789	<u>n+</u>	538 936
 OAK⁵ Light White Sauvage brushed 2V Matching skirting ID N° 409 614	<u>P_m</u>	529 268
 OAK⁵ Sand White Sauvage brushed 2V Matching skirting ID N° 409 789	<u>nD</u>	535 444
 NEW OAK ⁵ Sand White Sauvage brushed 4V Matching skirting ID N° 409 789	<u>n+</u>	538 937
 OAK WHITE BARRIQUE⁶ Selectiv brushed 4V Matching skirting ID N° 409 025	oleovera	529 063
 OAK Puro White Exklusiv brushed 4V Matching skirting ID N° 409 613	<u>n+</u>	531 679

Only delivered in complete cartons. HARO PARQUET with unfinished/sanded surface available on request; minimum purchasing quantity 200 sq.m.







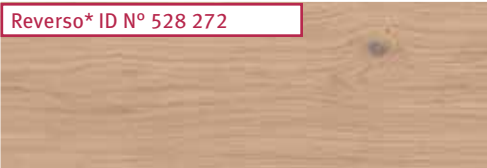

We reserve the right to supply one layer per carton in lengths below 2 m.

⁵ Splinters and core splits may form on the board surface. ⁶ Surface layer dimensions: 173 x 2200 mm

Dimensions: 13.5 x 180 x 2200 mm
 Top layer thickness: approx. 3.5 mm
 Packaging: 8 piece/pack = 3,17 m²
 32 pack/pallet = 101,44 m²
 7,41 kg/m²; 23,49 kg/pack;
 751,68 kg/pallet
 3-layer construction with solid wood strip middle layer



From 10 m² all articles on this page optionally available with ComforTec or Silent Pro (delivery time on inquiry).

Wood Species/Grade		Finish	ID N°
 NEW	OAK Puro White Markant brushed 2V	<u>Pm</u>	538 960
		<u>nD</u>	538 959
Matching skirting ID N° Pm 410 724/nD 409 613			
 Reverso* ID N° 528 272	OAK Puro White Markant brushed 4V	<u>n+</u>	527 326
Matching skirting ID N° 409 613			
 NEW	OAK⁵ Puro White Sauvage brushed 2V	<u>Pm</u>	538 962
		<u>nD</u>	538 961
Matching skirting ID N° Pm 410 724/ nD 409 613			
 NEW	OAK⁵ Puro White Sauvage brushed 4V	<u>n+</u>	530 195
Matching skirting ID N° 409 613			
 NEW	OAK⁵ Puro White Sauvage retro brushed 4V	<u>n+</u>	535 622
Matching skirting ID N° 409 613			
 NEW	OAK Puro White Alabama brushed 4V	<u>n+</u>	529 764
Matching skirting ID N° 409 613			
 NEW	FUMED OAK⁵ Puro White Sauvage brushed 4V	<u>n+</u>	538 940
Matching skirting ID N° 410 709			
 NEW	OAK Creme White Markant brushed 4V	<u>n+</u>	535 538
Matching skirting ID N° 410 036			
 NEW	OAK⁵ Creme White Sauvage brushed 4V	<u>n+</u>	535 542
Matching skirting ID N° 410 036			
 NEW	OAK⁵ Atelier Sauvage retro brushed 4V	<u>n+</u>	531 764
Matching skirting ID N° 409 042			

Only delivered in complete cartons. HARO PARQUET with unfinished/sanded surface available on request; minimum purchasing quantity 200 sq.m.
 We reserve the right to supply one layer per carton in lengths below 2 m.
⁵ Splinters and core splinters may form on the board surface.
 * Reverso direction-change board, price per item: 49,92 € excl. VAT



Dimensions: 13.5 x 180 x 2200 mm
 Top layer thickness: approx. 3.5 mm
 Packaging: 8 piece/pack = 3,17 m²
 32 pack/pallet = 101,44 m²
 7,41 kg/m²; 23,49 kg/pack;
 751,68 kg/pallet

3-layer construction with solid wood strip middle layer

From 10 m² all articles on this page optionally available with ComforTec or Silent Pro (delivery time on inquiry).

Wood Species/Grade		Finish	ID N°
	OAK invisible Markant brushed 2V	<u>P_m</u>	538 938
		<u>nD</u>	535 445
Matching skirting ID N° Pm 410 725/nD 409 733			
	OAK Invisible Markant brushed 4V	<u>n+</u>	535 617
	Matching skirting ID N° 409 733		
	OAK⁵ invisible Sauvage brushed 2V	<u>P_m</u>	538 939
		<u>nD</u>	535 446
Matching skirting ID N° Pm 410 725/nD 409 733			
	OAK⁵ Invisible Sauvage brushed 4V	<u>n+</u>	535 618
	Matching skirting ID N° 409 733		
	OAK Exklusiv	<u>P_m</u>	524 680
	Matching skirting ID N° 406 922		
	OAK Exklusiv brushed 4V	<u>n+</u>	531 677
	Matching skirting ID N° 409 612		
	OAK Markant	<u>P_m</u>	524 558
		<u>r</u>	524 713
Matching skirting ID N° 406 922			
Reverso* ID N° Pm 528 268		<u>P_m</u>	524 577
		<u>nD</u>	535 447
Matching skirting ID N° Pm 409 616/nD 409 612			
Reverso* ID N° 528 269		<u>n+</u>	528 682
Matching skirting ID N° 409 612			
Reverso* ID N° Pm 531 512		<u>P_m</u>	524 634
		<u>nD</u>	535 448
Matching skirting ID N° Pm 409 616/nD 409 612			

Only delivered in complete cartons. HARO PARQUET with unfinished/sanded surface available on request; minimum purchasing quantity 200 sq.m.

We reserve the right to supply one layer per carton in lengths below 2 m.

⁵ Splinters and core splits may form on the board surface.









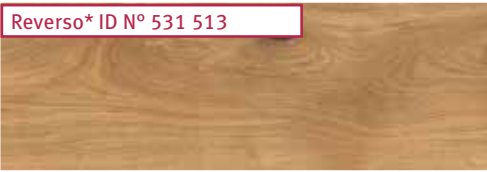

* Reverso direction-change board, price per item: 49,92 € excl. VAT

Dimensions: 13.5 x 180 x 2200 mm
 Top layer thickness: approx. 3.5 mm
 Packaging: 8 piece/pack = 3,17 m²
 32 pack/pallet = 101,44 m²
 7,41 kg/m²; 23,49 kg/pack;
 751,68 kg/pallet

3-layer construction with solid wood strip middle layer



From 10 m² all articles on this page optionally available with ComforTec or Silent Pro (delivery time on inquiry).

Wood Species/Grade		Finish	ID N°
	OAK⁵ Sauvage brushed 4V Matching skirting ID N° 409 612	<u>n+</u>	528 695
	OAK⁵ Sauvage retro brushed 4V Matching skirting ID N° 409 612	<u>n+</u>	530 793
	CREEK OAK³ brushed 4V Matching skirting ID N° 406 453	oleovera	529 067
	OAK NUBIA⁶ brushed 2V Matching skirting ID N° 406 453	oleovera	525 259
	OAK Alabama brushed 4V Matching skirting ID N° 409 612	<u>n+</u>	529 587
	VINTAGE OAK^{2,6} brushed 2V Matching skirting ID N° 406 453	oleovera	525 260
	OAK BARRIQUE⁶ Selectiv brushed 4V Matching skirting ID N° 408 688	oleovera	529 062
	FUMED OAK⁵ Invisible Sauvage brushed 4V Matching skirting ID N° 410 710	<u>n+</u>	538 941
	OAK⁵ Tobacco Grey Sauvage retro brushed 4V Matching skirting ID N° 408 680	<u>n+</u>	530 795
	OAK Sand Grey Markant brushed 2V Matching skirting ID N° Pm 410 726/nD 409 785	<u>Pm</u> <u>nD</u>	538 942 535 449

Only delivered in complete cartons. HARO PARQUET with unfinished/sanded surface available on request; minimum purchasing quantity 200 sq.m.

We reserve the right to supply one layer per carton in lengths below 2 m.

⁶ Surface layer dimensions: 173 x 2200 mm ⁵ Splinters and core splits may form on the board surface. ² Delivery time on inquiry











³ Delivery time: 4-6 weeks * Reverso direction-change board, price per item: 49,92 € excl. VAT



Dimensions: 13.5 x 180 x 2200 mm
 Top layer thickness: approx. 3.5 mm
 Packaging: 8 piece/pack = 3,17 m²
 32 pack/pallet = 101,44 m²
 7,41 kg/m²; 23,49 kg/pack;
 751,68 kg/pallet

3-layer construction with solid wood strip middle layer

From 10 m² all articles on this page optionally available with ComforTec or Silent Pro (delivery time on inquiry).

Wood Species/Grade	Finish	ID N°
NEW 	OAK Sand Grey Markant brushed 4V Matching skirting ID N° 409 785	<u>n+</u> 538 943
	OAK⁵ Sand Grey Sauvage brushed 2V Matching skirting ID N° Pm 410 726/nD 409 785	<u>Pm</u> <u>nD</u> 538 944 535 450
NEW 	OAK⁵ Sand Grey Sauvage brushed 4V Matching skirting ID N° 409 785	<u>n+</u> 538 945
NEW 	OAK Shell Grey Markant brushed 4V Matching skirting ID N° 410 711	<u>n+</u> 538 946
NEW 	OAK⁵ Shell Grey Sauvage brushed 4V Matching skirting ID N° 410 711	<u>n+</u> 538 947
	SMOKED OAK⁶ Markant brushed 2V Matching skirting ID N° 409 611	<u>nD</u> 535 465
	SMOKED OAK⁶ Markant brushed 4V Matching skirting ID N° 409 611	<u>n+</u> 528 678
	SMOKED OAK^{5 6} Sauvage brushed 2V Matching skirting ID N° 409 611	<u>nD</u> 535 466
Reverso* ID N° 528 275 	SMOKED OAK^{5 6} Sauvage brushed 4V Matching skirting ID N° 409 611	<u>n+</u> 530 148
	SMOKED OAK^{5 6} Sauvage retro brushed 4V Matching skirting ID N° 409 611	<u>n+</u> 534 152

Only delivered in complete cartons. HARO PARQUET with unfinished/sanded surface available on request; minimum purchasing quantity 200 sq.m.

We reserve the right to supply one layer per carton in lengths below 2 m .

⁵ Splinters and core splits may form on the board surface.









⁶ Dimensions: 13.5 x 173 x 2200 mm, Packaging: 8 piece/pack = 3,05 m² 32 pack/pallet = 97,6 m² 7,41 kg/m²; 22,6 kg/pack; 723,2 kg/pallet

* Reverso direction-change board, price per item: 49,92 € excl. VAT

Dimensions: 13.5 x 180 x 2200 mm
 Top layer thickness: approx. 3.5 mm
 Packaging: 8 piece/pack = 3,17 m²
 32 pack/pallet = 101,44 m²
 7,41 kg/m²; 23,49 kg/pack;
 751,68 kg/pallet
 3-layer construction with solid wood strip middle layer

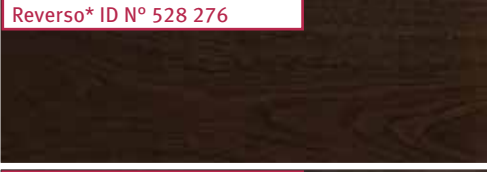
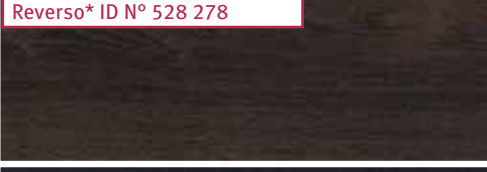

From 10 m² all articles on this page optionally available with ComforTec or Silent Pro (delivery time on inquiry).

Wood Species/Grade		Finish	ID N°
 NEW	FUMED OAK ⁵ Sauvage brushed 4V Matching skirting ID N° 410 708	<u>n+</u>	538 949
 NEW	OAK Reed Brown Markant brushed 4V Matching skirting ID N° 410 712	<u>n+</u>	539 088
 NEW	OAK ⁵ Reed Brown Sauvage brushed 4V Matching skirting ID N° 410 712	<u>n+</u>	539 089
	THERMO OAK ⁶ Forte brushed 4V Matching skirting ID N° 406 899	<u>n+</u>	531 766
 Reverso* ID N° 528 276	AFRICAN OAK ⁶ Matching skirting ID N° 406 933	<u>P_m</u>	524 777
 Reverso* ID N° 528 278	AFRICAN OAK ⁶ brushed 4V Matching skirting ID N° 409 610	<u>n+</u>	528 674
	OAK CARBON BLACK ⁶ Selectiv brushed 4V Matching skirting ID N° 408 741	oleovera	529 066
 NEW	BEECH STEAMED ⁵ Universal Matching skirting ID N° 406 923	<u>P_m</u>	538 950
	BEECH STEAMED ⁵ Universal 2V Matching skirting ID N° 406 891	<u>nD</u>	535 451

Only delivered in complete cartons. HARO PARQUET with unfinished/sanded surface available on request; minimum purchasing quantity 200 sq.m.

We reserve the right to supply one layer per carton in lengths below 2 m.
⁵ Splinters and core splits may form on the board surface.











⁶ Dimensions: 13.5 x 173 x 2200 mm, Packaging: 8 piece/pack = 3,05 m² 32 pack/pallet = 97,6 m² 7,41 kg/m²; 22,6 kg/pack; 723,2 kg/pallet
 * Reverso direction-change board, price per item: 49,92 € excl. VAT



Dimensions: 13.5 x 180 x 2200 mm
 Top layer thickness: approx. 3.5 mm
 Packaging: 8 piece/pack = 3,17 m²
 32 pack/pallet = 101,44 m²
 7,41 kg/m²; 23,49 kg/pack;
 751,68 kg/pallet

3-layer construction with solid wood strip middle layer

From 10 m² all articles on this page optionally available with ComforTec or Silent Pro (delivery time on inquiry).

Wood Species/Grade		Finish	ID N°
 NEW	BEECH STEAMED ⁵ Universal brushed 4V Matching skirting ID N° 409 786	<u>n+</u>	538 951
 NEW	ASH ⁵ Light White Universal brushed 2V Matching skirting ID N° 409 045	<u>P_m</u>	538 952
	ASH ⁵ Sand White Universal brushed 2V Matching skirting ID N° 409 789	<u>nD</u>	535 452
	ASH BARRIQUE ⁶ Selectiv brushed 4V Matching skirting ID N° 408 689	oleovera	529 064
	ASH OLIVE GREY ⁶ Expressiv brushed 4V Matching skirting ID N° 408 690	oleovera	529 065
	THERMO ASH ⁶ Mezzo brushed 4V Matching skirting ID N° 406 901	<u>n+</u>	531 772
	ASH FANCY ⁶ brushed 2V Matching skirting ID N° 408 682	<u>n+</u>	530 945
	CANADIAN MAPLE Markant Matching skirting ID N° 406 925	<u>P_m</u>	524 916
 NEW	LARCH ^{5 7} Puro White Universal brushed 4V Matching skirting ID N° 407 189	<u>n+</u>	538 953
 NEW	LARCH ^{5 7} Tobacco Grey Universal retro brushed 4V Matching skirting ID N° 410 156	<u>n+</u>	538 954

Only delivered in complete cartons. HARO PARQUET with unfinished/sanded surface available on request; minimum purchasing quantity 200 sq.m.

We reserve the right to supply one layer per carton in lengths below 2 m.

⁵ Splinters and core splits may form on the board surface.







⁶ Dimensions: 13.5 x 173 x 2200 mm, Packaging: 8 piece/pack = 3,05 m² 32 pack/pallet = 97,6 m² 7,19 kg/m²; 21,93 kg/pack; 701,76 kg/pallet

⁷ Larch Dimensions: 13.5 x 180 x 2200 mm, Packaging: 8 piece/pack = 3,17 m² 32 pack/pallet = 101,44 m² 7,19 kg/m²; 22,79 kg/pack; 729,28 kg/pallet

Dimensions: 13.5 x 180 x 2200 mm
 Top layer thickness: approx. 3.5 mm
 Packaging: 8 piece/pack = 3,17 m²
 32 pack/pallet = 101,44 m²
 7,41 kg/m²; 23,49 kg/pack;
 751,68 kg/pallet
 3-layer construction with solid wood strip middle layer



From 10 m² all articles on this page optionally available with ComforTec or Silent Pro (delivery time on inquiry).

Wood Species/Grade	Finish	ID N°
 <p>LARCH^{5 7} Universal brushed 4V</p> <p>Matching skirting ID N° 406 898</p>	<u>n+</u>	538 955
 <p>AMERICAN WALNUT² Markant</p> <p>Matching skirting ID N° 406 931</p>	<u>Pm</u>	529 976
 <p>AMERICAN WALNUT² Markant 2V</p> <p>Matching skirting ID N° 406 896</p>	<u>nD</u>	535 453
 <p>AMERICAN WALNUT² Markant 4V</p> <p>Matching skirting ID N° 406 896</p>	<u>n+</u>	533 051
 <p>AMERICAN WALNUT^{2 5} Universal 4V</p> <p>Matching skirting ID N° 406 896</p>	<u>n+</u>	538 956
 <p>MERBAU^{1 9} Universal</p> <p>Matching skirting ID N° 406 930</p>	<u>Pm</u>	524 928

Only delivered in complete cartons. HARO PARQUET with unfinished/sanded surface available on request; minimum purchasing quantity 200 sq.m.

We reserve the right to supply one layer per carton in lengths below 2 m.

⁵ Splinters and core splits may form on the board surface. ² Delivery time on inquiry ¹ See note on exotic woods on page 12.

⁷ Larch Dimensions: 13.5 x 180 x 2200 mm, Packaging: 8 piece/pack = 3,17 m² 32 pack/pallet = 101,44 m² 7,19 kg/m²; 22,79 kg/pack; 729,28 kg/pallet

⁹ Merbau Dimensions: 13.5 x 180 x 2200 mm, Packaging: 8 piece/pack = 3,17 m² 32 pack/pallet = 101,44 m² 8,02 kg/m²; 25,42 kg/pack; 813,44 kg/pallet



HARO PARQUET 4000
Plank 1-Strip 4V
OAK
MARKANT

HARO Sports is a business unit of Hamberger Flooring and has installed more than 20.000 floors worldwide including sites for the Olympic Games, world and continental championships.

HARO®
Sports Flooring

HARO Sports permanent and portable sports floors offer a fast and easy installation, much lower maintenance costs, exceptional life span, greater safety for the athletes and superior quality. Our hardwood floors enjoy a flexible, engineered construction that almost eliminates swelling and shrinking, gaps and cracks that are common in conventional strip hardwood floors. This method features a solid hardwood top layer supported by a premium quality birch plywood core layer. The hardwood top layer receives a factory applied PermaDur® Sports finish for superior performance and surface protection. Each of the eight layers of PermaDur® Sports finish is individually UV cured, which provides a harder and more durable surface and does not require refinishing within the first 10-15 years.

You are interested in sports flooring?
Please feel free to contact us for further information.

Contact: **Stefan Kuner** – Division Manager HARO SPORTS
P.O. Box: 10 03 53 – 83003 Rosenheim – GERMANY
Tel.: +49 8031 700 500
info@haro-sports.com



www.haro-sports.com

Plank 1-Strip Plaza 4000 Series

The spacious and impressive HARO premium floor

240 (220) x 2200 mm



- Very spacious effect, high-class appearance
- The deep brushed texture emphasises the natural wood grain
- Excellent price/performance ratio
- Resandable
- Solid wood strip middle layer made of spruce
- Suitable for use with underfloor heating and cooling
- With Top Connect, one of the world's fastest installation systems; easy to install with no tools required

HARO PARQUET 4000 Plank 1-Strip Plaza

Top layer thickness: approx. 3,5 mm
Surface layer dimensions: 240 x 2200 mm
(Exception: Smoked Oak: 220 x 2200 mm)
Overall thickness: approx. 13.5 mm

Surface:

nD naturaDur

n+ naturaLin plus



**Fold Down
locking system**



HARO PARQUET 4000
Plank 1-Strip Plaza 4V
SMOKED OAK
UNIVERSAL
Alpine brushed



Dimensions: 13.5 x 240 x 2200 mm
 Top layer thickness: approx. 3.5 mm
 Packaging: 6 piece/pack = 3,17 m²
 33 pack/pallet = 104,61 m²
 7,41 kg/m²; 23,49 kg/pack;
 775,17 kg/pallet











3-ply construction with solid wood strip middle layer

PLANK 1-STRIP

PARQUET

Plaza 4000 Series

From 10 m² all articles on this page optionally available with ComforTec or Silent Pro (delivery time on inquiry).

Wood Species/Grade		Finish	ID N°
	OAK Sand White Markant brushed 4V	<u>nD</u>	536 545
	Matching skirting ID N° 409 789		
	OAK Puro White Markant brushed 4V	<u>n+</u>	537 606
	Matching skirting ID N° 409 613		
	OAK ⁵ Puro White Sauvage brushed 4V	<u>n+</u>	537 607
	Matching skirting ID N° 409 613		
NEW 	OAK ⁵ Puro White Universal Alpine brushed 4V	<u>n+</u>	538 963
	Matching skirting ID N° 409 613		
NEW 	OAK Invisible Markant brushed 4V	<u>n+</u>	538 964
	Matching skirting ID N° 409 733		
NEW 	OAK ⁵ Invisible Sauvage brushed 4V	<u>n+</u>	538 965
	Matching skirting ID N° 409 733		
	OAK Markant brushed 4V	<u>nD</u>	536 546
	Matching skirting ID N° 409 612	<u>n+</u>	536 974
	OAK ⁵ Sauvage brushed 4V	<u>n+</u>	536 975
	Matching skirting ID N° 409 612		
NEW 	OAK ⁵ Universal Alpine brushed 4V	<u>n+</u>	538 966
	Matching skirting ID N° 409 612		
NEW 	OAK ⁵ Tobacco Grey Universal Alpine brushed 4V	<u>n+</u>	538 967
	Matching skirting ID N° 408 680		

PLANK 1-STRIP

Only delivered in complete cartons. HARO PARQUET with unfinished/sanded surface available on request; minimum purchasing quantity 200 sq.m. We reserve the right to supply one layer per carton in lengths below 2 m.



⁵ Splinters and core splits may form on the board surface.

Dimensions: 13.5 x 240 x 2200 mm
 Top layer thickness: approx. 3.5 mm
 Packaging: 6 piece/pack = 3,17 m²
 33 pack/pallet = 104,61 m²
 7,41 kg/m²; 23,49 kg/pack;
 775,17 kg/pallet

3-ply construction with solid wood strip middle layer



From 10 m² all articles on this page optionally available with ComforTec or Silent Pro (delivery time on inquiry).

Wood Species/Grade		Finish	ID N°
NEW 	SMOKED OAK ^{5 6} Universal brushed 4V Matching skirting ID N° 409 611	<u>n+</u>	537 609
	SMOKED OAK ^{5 6} Universal Alpine brushed 4V Matching skirting ID N° 409 611	<u>n+</u>	533 499
NEW 	FUMED OAK ⁵ Sauvage brushed 4V Matching skirting ID N° 410 708	<u>n+</u>	538 968

Only delivered in complete cartons. HARO PARQUET with unfinished/sanded surface available on request; minimum purchasing quantity 200 sq.m.
 We reserve the right to supply one layer per carton in lengths below 2 m.

⁵ Splinters and core splits may form on the board surface.

⁶ Dimensions: 13.5 x 220 x 2200 mm, Packaging: 6 piece/pack = 2,9 m² ; 33 pack/pallet = 95,7 m² ; 7,41 kg/m²; 21,49 kg/pack; 709,17 kg/pallet



HARO PARQUET 4000
Plank 1-Strip Plaza 4V
OAK
MARKANT
brushed

parkettmanufaktur by HARO

The Fine Art
of Parquet Craftsmanship





Our floors from parkettmanufaktur by HARO represent the fine art of parquet craftsmanship. It is not only the selected precious wood, the amazing surfaces and the appealing formats that make our premium segment so special; it is also the wide range of individualisation options. Our parquet experts refine your floorboards with traditional woodworking techniques – from hand-scraping and hand-brushing to frame-sawn surfaces and wormhole appearance.

Your HARO dealer will be pleased to show you the exclusive individuality of our premium flooring.

Plank 1-Strip XL

- The biggest for spacious interior designs.
- Available in the format 3030 mm x 245 mm (optionally also in lengths of 1800 mm, 2000 mm and 2200 mm and in the format 4030 mm x 305 mm.
- Top layer thickness: approx. 5 mm

Plank 1-Strip and Plank 1-Strip Plaza

- Impressive naturalness and spaciousness in the format 2200 mm x 180 mm. and for Plank 1-Strip Plaza 2200 x 240 mm
- Top layer thickness: approx. 3.5 mm
- Oak Nubia, Vintage Oak and all colour-refined surfaces are available in the format 2200 mm x 173 mm
- Easy to install with Top Connect – also on underfloor heating and cooling

NEW

Strip Prestige and Strip Plank 1-Strip Scala

- Customisation options are now also available for 2-layer parquet
- Due to the low construction height of just 10 mm, it is particularly suitable for renovations and for glue-down installation on underfloor heating and cooling systems..
- Top layer thickness: approx. 3.5 mm
- Strip Prestige – Suitable for herringbone installation

NEW

Carré

- Natural individuality in the format 2200 mm x 180 mm
- Top layer thickness: approx. 4.2 mm
- Suitable for use with underfloor heating and cooling
- State-of-the-art with coloured oil surface finishes

Parquet Tile

- The most exclusive form of a parquet floor.
- Traditional design with modern features, such as bevelled edges and oleovera natural oil surface finishes.
- 4 different designs in up to 6 different wood types

The products shown in the following range overview are stock items.

For the wide variety of individualisation options, please see pages 46 - 51

Examples of floors from the customisation programme are shown on pages 52 to 54.

Plank 1-Strip XL 4m

Dimensions:

18 x 245 x 1800 - 2200 mm,
18 x 245 x 3030 mm,
18 x 305 x 4030 mm

Top layer thickness: approx.: 5 mm

Surface: oleoverea

3-ply construction with solid wood strip middle layer



Wood Species/Grade		Formats (mm)	ID N°
	OAK * Selectiv brushed 4V	245x1800	528 924
		245x2000	528 926
	Matching skirting ID N° 406 453	245x2200	528 928
	PLANK XL AMBER SMOKED OAK * strukturiert 4V	245x1800	528 925
		245x2000	528 927
	Matching skirting ID N° 407 626	245x2200	528 929
	PLANK 1-STRIP XL 3M/4M OAK * strukturiert 4V	245x3030	526 958
		305x4030	525 999
	Matching skirting ID N° 406 453		
	PLANK XL 3M/4M AMBER SMOKED OAK * strukturiert 4V	245x3030	526 000
		305x4030	526 001
	Matching skirting ID N° 407 626		

* Plank XL is only available for mixed orders of all three lengths.

** Plank XL 3m/4m is only available for mixed orders.

Delivery time approx. 3 to 6 weeks. Other board widths and lengths are available on request!

Carré

Dimensions: 16 x 180 x 2200 mm

Top layer thickness: approx.: 4.2 mm

Packaging: 7 piece/pack = 2,77 m²

32 pack/pallet = 88,64 m²

9,06 kg/m²; 25,1 kg/pack;

803,2 kg/pallet

3-ply construction with solid wood strip middle layer



Wood Species/Grade		Finish	ID N°
	OAK¹⁰ Blue Grey Selectiv	oleovera	539 074
	Matching skirting ID N° 526 221		
	OAK¹⁰ Silver Grey Selectiv	oleovera	539 075
	Matching skirting ID N° 526 222		
	OAK Selectiv	Pm	529 069
	Matching skirting ID N° 406 453		
	OAK¹⁰ Antique Brown Selectiv	oleovera	539 076
	Matching skirting ID N° 406 906		

Delivery time approx. 3 - 6 weeks. Please add the cutting waste when calculating the needed amount of material.

Minimum quantity: 2.77 m²







¹⁰ Initial treatment with aqua oil or Oil Balm is necessary after installation.



Dimensions: 13.5 x 180 x 2200 mm
 Top layer thickness: approx.: 3.5 mm
 Packaging: 8 piece/pack = 3,17 m²
 32 pack/pallet = 101,44 m²
 7,41 kg/m²; 23,49 kg/pack;
 751,68 kg/pallet

Plank 1-Strip

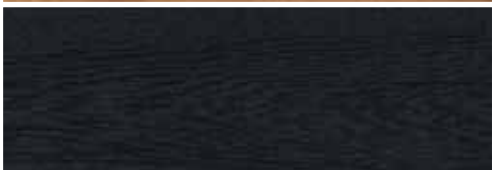
3-layer construction with solid wood strip middle layer

Wood Species/Grade		Finish	ID N°
	OAK WHITE BARRIQUE⁶ SELECTIV brushed 4V Matching skirting ID N° 409 025	oleovera	529 063
	OAK BARRIQUE⁶ Selectiv brushed 4V Matching skirting ID N° 408 688	oleovera	529 062
	CREEK OAK⁷ brushed 4V Matching skirting ID N° 406 453	oleovera	529 067
	OAK NUBIA⁶ brushed 2V Matching skirting ID N° 406 453	oleovera	525 259
	VINTAGE OAK^{2 6} brushed 2V Matching skirting ID N° 406 453	oleovera	525 260
	OAK CARBON BLACK⁶ Selectiv brushed 4V Matching skirting ID N° 408 741	oleovera	529 066
	ASH BARRIQUE⁶ Selectiv brushed 4V Matching skirting ID N° 408 689	oleovera	529 064
	ASH OLIVE GREY⁶ Expressiv brushed 4V Matching skirting ID N° 408 690	oleovera	529 065

Delivery time approx. 3 to 4 weeks. Please add the cutting waste when calculating the needed amount of material.

Minimum quantity: 3.05 m²

⁶ Surface layer dimensions: 173 x 2200 mm² Delivery time on inquiry

⁷ Delivery time: 4-6 weeks

Customisation options

Plank 1-Strip

				Smooth without bevel on long sides	Smooth with bevel on long sides
PLANK 1-STRIP 13,5 x 180 (173) x 2200 mm					
		ID N°	Finish	no extra charge	ID N° 800 817 no extra charge
	OAK	ID N°	Oleovera		
	EXCELLENT	524 681	ID N° 800 947	<input type="checkbox"/>	<input type="checkbox"/>
	SELECTIV	524 712			
	OAK LIME WHITE	ID N°	Oleovera		
	EXCELLENT	524 681	Lime White ID N° 801 618	<input type="checkbox"/>	<input type="checkbox"/>
	SELECTIV	524 712			
	OAK WHITE	ID N°	Oleovera		
	EXCELLENT	524 681	White ID N° 800 949	<input type="checkbox"/>	<input type="checkbox"/>
	SELECTIV	524 712			
	OAK NATURAL WHITE	ID N°	Oleovera		
	EXCELLENT	524 681	Natural White ID N° 801 619	<input type="checkbox"/>	<input type="checkbox"/>
	SELECTIV	524 712			
	OAK BLUE GREY	ID N°	Oleovera		
	EXCELLENT	524 681	Blue Grey ID N° 801 136	<input type="checkbox"/>	<input type="checkbox"/>
	SELECTIV	524 712			
	OAK SILVER GREY	ID N°	Oleovera		
	EXCELLENT	524 681	Silver Grey	<input type="checkbox"/>	<input type="checkbox"/>
	SELECTIV	524 712	ID N°. 801 137		
	OAK BROWN GREY	ID N°	Oleovera		
	EXCELLENT	524 681	Brown Grey	<input type="checkbox"/>	<input type="checkbox"/>
	SELECTIV	524 712	ID N° 801 620		
	OAK NATURAL GREY	ID N°	Oleovera		
	EXCELLENT	524 681	Natural Grey ID N° 801 621	<input type="checkbox"/>	<input type="checkbox"/>
	SELECTIV	524 712			
	OAK BEIGE GREY	ID N°	Oleovera		
	EXCELLENT	524 681	Beige Grey	<input type="checkbox"/>	<input type="checkbox"/>
	SELECTIV	524 712	ID N° 801 622		
	OAK BASALT GREY	ID N°	Oleovera		
	EXCELLENT	524 681	Basalt Grey ID N° 801 623	<input type="checkbox"/>	<input type="checkbox"/>
	SELECTIV	524 712			
	SMOKED OAK	ID N°	Oleovera		
	SELECTIV	524 806	ID N° 800 947	<input type="checkbox"/>	<input type="checkbox"/>
	SMOKED OAK WHITE	ID N°	Oleovera White		
	SELECTIV	524 806	ID N° 800 949	<input type="checkbox"/>	<input type="checkbox"/>
	AFRICAN OAK	ID N°	Oleovera		
	SELECTIV	524 775	ID N° 800 947	<input type="checkbox"/>	<input type="checkbox"/>
	OAK ARABICA FORTE	ID N°	Oleovera		
	SELECTIV	524 820	ID N° 800 947	<input type="checkbox"/>	<input type="checkbox"/>
	ASH ARABICA MEZZO	ID N°	Oleovera		
	SELECTIV	524 909	ID N° 800 947	<input type="checkbox"/>	<input type="checkbox"/>
	AFRICAN OAK SILVER	ID N°	Oleovera Silver limew.		
	Limewashed	524 775	ID N° 801 140	—	—
	AFRICAN OAK GOLD	ID N°	Oleovera Gold limew.		
	Limewashed	524 775	ID N° 801 141	—	—

Choose your individual floor with the following surface treatments and additional options.

Plank 1-Strip

Dimensions: 13,5 x 180 x 2200 mm
 respectively 13,5 x 173 x 2200 mm for Smoked Oak, African Oak, Ash Arabica, Oak Arabica

Minimum quantity: per pack, = 3.17 or 3.05 m²

Installation system: Top Connect

■ possible
 — Not available









SURFACE TREATMENT - SELECT ONE OPTION ONLY					ADDITIONAL OPTION - SEVERAL OPTIONS CAN BE SELECTED			
Brushed with bevel on long sides	Scraped with bevel on long sides**	Handscraped with bevel on long sides**	Frame sawn with bevel on long sides**	Deep brushed with bevel on long sides	Bevel on short sides	Worm-hole appearance	Hammered surface	Silent Pro
ID N°	ID N°	ID N°	ID N°	ID N°	ID N°	ID N°	ID N°	ID N°
800 822	800 823	800 930	801 173	801 346	800 824	800 821	801 174	800 820
■	■	■	■	■	■	■	■	■
■	■	■	■	■	■	■	■	■
■	■	■	■	■	■	■	■	■
■	■	■	■	■	■	■	■	■
■	■	■	■	■	■	■	■	■
■	■	■	■	■	■	■	■	■
■	■	■	■	■	■	■	■	■
■	■	■	■	■	■	■	■	■
■	■	■	■	■	■	■	■	■
■	■	■	■	■	■	■	■	■
■	■	■	■	■	■	■	■	■
■	■	■	■	■	■	■	■	■
■	■	■	■	■	■	■	■	■
■	■	■	■	■	■	■	■	■
■	■	■	■	■	■	■	■	■
■	■	■	■	■	■	■	■	■
■	■	■	■	■	■	■	■	■
■	■	■	■	■	■	■	■	■
■	■	■	■	■	■	■	■	■
■	■	■	■	■	■	■	■	■
■	■	■	■	■	■	■	■	■
■	■	■	■	■	■	■	■	■
■	■	■	■	■	■	■	■	■
■	■	■	■	■	■	■	■	■

PARKETMANUFAKTUR

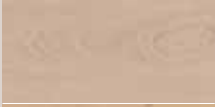
** The "Bevel on short sides" option is mandatory with "Scraped with bevel on long sides" and "Frame sawn with bevel on long sides" surface treatments!

Customisation options

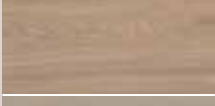
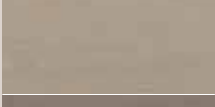
Plank 1-Strip Plaza

 PLANK 1-STRIP PLAZA 13,5 x 240 x 2200 mm				Smooth without bevel on long sides	Smooth with bevel on long sides
				no extra charge	ID N° 800 817 no extra charge
	OAK SELECTIV	ID N° 535 662	Oleovera ID N° 800 947	<input type="checkbox"/>	<input type="checkbox"/>
	OAK LIME WHITE SELECTIV	ID N° 535 662	Oleovera Lime White ID N° 801 618	<input type="checkbox"/>	<input type="checkbox"/>
	OAK WHITE SELECTIV	ID N° 535 662	Oleovera White ID N° 800 949	<input type="checkbox"/>	<input type="checkbox"/>
	OAK NATURAL WHITE SELECTIV	ID N° 535 662	Oleovera Natural White ID N° 801 619	<input type="checkbox"/>	<input type="checkbox"/>
	OAK BLUE GREY SELECTIV	ID N° 535 662	Oleovera Blue Grey ID N° 801 136	<input type="checkbox"/>	<input type="checkbox"/>
	OAK SILVER GREY SELECTIV	ID N° 535 662	Oleovera Silver Grey ID N° 801 137	<input type="checkbox"/>	<input type="checkbox"/>
	OAK BROWN GREY SELECTIV	ID N° 535 662	Oleovera Brown Grey ID N° 801 620	<input type="checkbox"/>	<input type="checkbox"/>
	OAK NATURAL GREY SELECTIV	ID N° 535 662	Oleovera Natural Grey ID N° 801 621	<input type="checkbox"/>	<input type="checkbox"/>
	OAK BEIGE GREY SELECTIV	ID N° 535 662	Oleovera Beige Grey ID N° 801 622	<input type="checkbox"/>	<input type="checkbox"/>
	OAK BASALT GREY SELECTIV	ID N° 535 662	Oleovera Basalt Grey ID N° 801 623	<input type="checkbox"/>	<input type="checkbox"/>

Choose your individual floor with the following surface treatments and additional options.

Plank 1-Strip Plaza:

Dimensions: 13,5 x 240 x 2200 mm

Minimum order quantity: per pack i.e. 3.17 m²

Installation system: Top Connect

■ possible
— Not available

SURFACE TREATMENT - SELECT ONE OPTION ONLY					ADDITIONAL OPTION - SEVERAL OPTIONS CAN BE SELECTED			
Brushed with bevel on long sides	Scraped with bevel on long sides**	Handscraped with bevel on long sides**	Frame sawn with bevel on long sides**	Deep brushed with bevel on long sides	Bevel on short sides	Worm-hole appearance	Hammered surface	Silent Pro
ID N° 800 822	ID N° 800 823	ID N° 800 930	ID N° 801 173	ID N° 801 346	ID N° 800 824	ID N° 800 821	ID N° 801 174	ID N° 800 820
■	■	■	■	■	■	■	■	—
■	■	■	■	■	■	■	■	—
■	■	■	■	■	■	■	■	—
■	■	■	■	■	■	■	■	—
■	■	■	■	■	■	■	■	—
■	■	■	■	■	■	■	■	—
■	■	■	■	■	■	■	■	—
■	■	■	■	■	■	■	■	—
■	■	■	■	■	■	■	■	—
■	■	■	■	■	■	■	■	—

** The "Bevel on short sides" option is mandatory with "Scraped with bevel on long sides" and "Frame sawn with bevel on long sides" surface treatments!

Customisation options

Strip Prestige and Strip Plank 1-Strip Scala

STRIP PRESTIGE			
10,0 x 120 x 1000 mm			
		ID N°	Finish
	OAK SELECTIV	523 442	Oleovera ID N° 800 947
	OAK LIME WHITE SELECTIV	523 442	Oleovera Lime White ID N° 801 618
	OAK WHITE SELECTIV	523 442	Oleovera White ID N° 800 949
	OAK NATURAL WHITE SELECTIV	523 442	Oleovera Natural White ID N° 801 619
	OAK BLUE GREY SELECTIV	523 442	Oleovera Blue Grey ID N° 801 136
	OAK SILVER GREY SELECTIV	523 442	Oleovera Silver Grey ID N° 801 137
	OAK BROWN GREY SELECTIV	523 442	Oleovera Brown Grey ID N° 801 620
	OAK NATURAL GREY SELECTIV	523 442	Oleovera Natural Grey ID N° 801 621
	OAK BEIGE GREY SELECTIV	523 442	Oleovera Beige Grey ID N° 801 622
	OAK BASALT GREY SELECTIV	523 442	Oleovera Basalt Grey ID N° 801 623

STRIP PLANK SCALA			
10,0 x 160 x 1750 mm			
		ID N°	Finish
	OAK SELECTIV	539 080	Oleovera ID N° 800 947
	OAK LIME WHITE SELECTIV	539 080	Oleovera Lime White ID N° 801 618
	OAK WHITE SELECTIV	539 080	Oleovera White ID N° 800 949
	OAK NATURE WHITE SELECTIV	539 080	Oleovera Nature White ID N° 801 619
	OAK BLUE GREY SELECTIV	539 080	Oleovera Blue Grey ID N° 801 136
	OAK SILVER GREY SELECTIV	539 080	Oleovera Silver Grey ID N° 801 137
	OAK BROWN GREY SELECTIV	539 080	Oleovera Brown Grey ID N° 801 620
	OAK NATURAL GREY SELECTIV	539 080	Oleovera Natural Grey ID N° 801 621
	OAK BEIGE GREY SELECTIV	539 080	Oleovera Beige Grey ID N° 801 622
	OAK BASALT GREY SELECTIV	539 080	Oleovera Basalt Grey ID N° 801 623

Choose your individual floor with the following surface treatments and additional options.

Strip Prestige:

Dimensions: 10 x 120 x 1000 mm
 Minimum order quantity: per pack, i.e. 3.12 sq.m.
 Installation system: Tongue/groove

Strip Plank Scala:

Dimensions: 10 x 160 x 1750 mm
 Minimum order quantity: per pack, i.e. 3.64 sq.m.
 Installation system: Tongue/groove

■ possible
 — Not available

SURFACE TREATMENT - SELECT ONE OPTION ONLY

ADDITIONAL OPTION - SEVERAL OPTIONS CAN BE SELECTED

Brushed with bevel on long sides	Scraped with bevel on long sides**	Handscraped with bevel on long sides**	Frame sawn with bevel on long sides**	Deep brushed with bevel on long sides	Bevel on short sides	Worm-hole appearance	Hammered surface	Silent Pro
ID N° 800 822	ID N° 800 823	ID N° 800 930	ID N° 801 173	ID N° 801 346	ID N° 800 824	ID N° 800 821	ID N° 801 174	ID N° 800 820
■	■	■	■	■	■	■	■	—
■	■	■	■	■	■	■	■	—
■	■	■	■	■	■	■	■	—
■	■	■	■	■	■	■	■	—
■	■	■	■	■	■	■	■	—
■	■	■	■	■	■	■	■	—
■	■	■	■	■	■	■	■	—
■	■	■	■	■	■	■	■	—
■	■	■	■	■	■	■	■	—
■	■	■	■	■	■	■	■	—
■	■	■	■	■	■	■	■	—

Brushed with bevel on long sides	Scraped with bevel on long sides**	Handscraped with bevel on long sides**	Frame sawn with bevel on long sides**	Deep brushed with bevel on long sides	Bevel on short sides	Worm-hole appearance	Hammered surface	Silent Pro
ID N° 800 822	ID N° 800 823	ID N° 800 930	ID N° 801 173	ID N° 801 346	ID N° 800 824	ID N° 800 821	ID N° 801 174	ID N° 800 820
■	■	■	■	■	■	■	■	—
■	■	■	■	■	■	■	■	—
■	■	■	■	■	■	■	■	—
■	■	■	■	■	■	■	■	—
■	■	■	■	■	■	■	■	—
■	■	■	■	■	■	■	■	—
■	■	■	■	■	■	■	■	—
■	■	■	■	■	■	■	■	—
■	■	■	■	■	■	■	■	—
■	■	■	■	■	■	■	■	—
■	■	■	■	■	■	■	■	—

** The "Bevel on short sides" option is mandatory with "Scraped with bevel on long sides" and "Frame sawn with bevel on long sides" surface treatments!



MASTER PIECE



The floors from our parkettmanufaktur offer a large variety of customisation options; from coloured oils and numerous surface treatments to the selection of bevelled edges on the short sides that highlight the natural look of the floor even more. The following examples will show you the most attractive combination possibilities for your floor. Our aim is to make your decision for a unique floor as easy as possible.





Plank 1-Strip
OAK EXCELLENT ID N° 524 681

Customisation options:

- Oleovera ID N° 800 947
- smooth, without bevelled edge



Plank 1-Strip
OAK NATURE GREY EXCELLENT ID N° 524 681

Customisation options:

- Oleovera Natural Grey ID N° 801 621
- brushed with bevelled edge on long sides ID N° 800 822



Plank 1-Strip
OAK CHALK WHITE SELECTIV ID N° 524 712

Customisation options:

- Oleovera Lime White ID N° 801 618
- frame sawn with bevelled edge on long sides ID N° 801 173
- Bevel on short sides ID N° 800 824



Plank 1-Strip
OAK BLUE GREY SELECTIV ID N° 524 712

Customisation options:

- Oleovera Blue Grey ID N° 801 136
- brushed with bevelled edge on long sides ID N° 800 822
- Bevel on short sides ID N° 800 824
- Hammered surface ID N° 801 174



Plank 1-Strip
OAK BASALT GREY SELECTIV ID N° 524 712

Customisation options:

- Oleovera Basalt Grey ID N° 801 623
- hand-scraped with bevelled edge on long sides ID N° 800 930
- Bevel on short sides ID N° 800 824





Plank 1-Strip
SMOKED OAK SELECTIV ID N° 524 806

Customisation options:

- Oleovera ID N° 800 947
- frame sawn with bevelled edge on long sides ID N° 801 173
- Bevel on short sides ID N° 800 824
- Worm-hole appearance ID N° 800 821



Plank 1-Strip
SMOKED OAK WHITE Selectiv ID N° 524 806

Customisation options:

- Oleovera White ID N° 800 949
- hand-scraped with bevelled edge on long sides ID N° 800 930
- Bevel on short sides ID N° 800 824



Plank 1-Strip
AFRICAN OAK SELECTIV ID N° 524 775

Customisation options:

- Oleovera ID N° 800 947
- rough-planed with bevelled edge on long sides ID N° 800 823
- Bevel on short sides ID N° 800 824



Plank 1-Strip
OAK ARABICA FORTE SELECTIV ID N° 524 820

Customisation options:

- Oleovera ID N° 800 947
- heavy brushed, with bevel ID N° 801 346



Plank 1-Strip
ASH ARABICA MEZZO SELECTIV ID N° 524 909

Customisation options:

- Oleovera ID N° 800 947
- hand-scraped with bevelled edge on long sides ID N° 800 930
- Bevel on short sides ID N° 800 824
- Worm-hole appearance ID N° 800 821



Plank 1-Strip
AFRICAN OAK SILVER LIMEWASHED ID N° 524 775

Customisation options:

- Oleovera Silver limewashed ID N° 801 140
- brushed with bevelled edge on long sides ID N° 800 822



Plank 1-Strip Plaza
OAK SELECTIV ID N° 535 662

Customisation options:

- Oleovera ID N° 800 947
- rough-planed with bevelled edge on long sides ID N° 800 823
- Bevel on short sides ID N° 800 824



Plank 1-Strip Plaza
OAK CHALK WHITE SELECTIV ID N° 535 662

Customisation options:

- Oleovera Lime White ID N° 801 618
- smooth, with bevelled edge on long sides ID N° 800 817
- Bevel on short sides ID N° 800 824



Plank 1-Strip Plaza
OAK BROWN GREY SELECTIV ID N° 535 662

Customisation options:

- Oleovera Brown Grey ID N° 801 620
- hand-scraped with bevelled edge on long sides ID N° 800 930
- Bevel on short sides ID N° 800 824



Strip Prestige
OAK SELECTIV ID N° 523 442

Customisation options:

- Oleovera ID N° 800 947
- rough-planed, with bevel ID N° 800 823
- Bevel on short sides ID N° 800 824



Strip Prestige
OAK SILVER GREY SELECTIV ID N° 523 442

Customisation options:

- Oleovera Silver Grey ID N° 801 137
- heavy brushed, with bevel ID N° 801 346
- Bevel on short sides ID N° 800 824

parkettmanufaktur by HARO

Parquet in tile design



parkettmanufaktur by HARO
PARQUET TILE
Design St. Andrew
American walnut



- Hand-crafted parquet tiles made from the most precious woods.
- Four different tile designs consisting of individual elements, combined into a strong expressive surface in 5 or 6 wood types
- Precious oleovera natural oil finish
- Installation system: Complete tongue and groove joints on all four sides for glue-down installation with flexible glue

parkettmanufaktur by HARO
Parquet Tile

Top layer thickness: approx. 3.5 mm
Total thickness: approx. 18 mm

Finish:
oleovera



3-layer construction for glue-down installation

1. Approx. 3.5 mm thick top layer of choice precious wood
2. Birchwood multiplex board as middle layer, approx. 10 mm thick
3. Backing board made of oak

Design



DESIGN BASKET
African Oak



DESIGN ST.ANDREW
Ash Arabica Mezzo









DESIGN LOOP
American walnut



DESIGN CENTRAL
Merbau

Total thickness: approx. 18 mm
 Top layer thickness: approx. 3.5 mm
 Dimensions: 650 x 650 mm
 Packaging: 2 piece/pack
 Layer construction with plywood middle layer
 Installation system: Complete tongue and groove joints on all four sides for glue-down installation with flexible glue
 Bevel: on all four sides
 Finish: oleovera



Design		Finish	ID N°
	ASH ARABICA MEZZO Basket	oleovera	535 299
	OAK Basket	oleovera	535 300
	AFRICAN OAK Basket	oleovera	535 302
	MERBAU Basket	oleovera	535 303
	AMERICAN WALNUT Basket	oleovera	535 304
	RÄUCHEREICHE Basket	oleovera	535 305







Total thickness: approx. 18 mm
 Top layer thickness: approx. 3.5 mm
 Dimensions: 650 x 650 mm
 Packaging: 2 piece/pack
 Layer construction with plywood middle layer
 Installation system: Complete tongue and groove joints on all four sides for glue-down installation with flexible glue
 Bevel: on all four sides
 Finish: oleovera

Parquet Tile Design St. Andrew

Design		Finish	ID N°
	ASH ARABICA MEZZO St. Andrew	oleovera	535 311
	OAK St. Andrew	oleovera	535 312
	AFRICAN OAK St. Andrew	oleovera	535 313
	MERBAU St. Andrew	oleovera	535 314
	AMERICAN WALNUT St. Andrew	oleovera	535 315

Total thickness: approx. 18 mm
 Top layer thickness: approx. 3.5 mm
 Dimensions: 650 x 650 mm
 Packaging: 2 piece/pack
 Layer construction with plywood middle layer
 Installation system: Complete tongue and groove joints on all four sides for glue-down installation with flexible glue
 Bevel: on all four sides
 Finish: oleovera







Design		Finish	ID N°
	<p>ASH ARABICA MEZZO Loop</p>	oleovera	535 316
	<p>OAK Loop</p>	oleovera	535 317
	<p>AFRICAN OAK Loop</p>	oleovera	535 318
	<p>MERBAU Loop</p>	oleovera	535 319
	<p>AMERICAN WALNUT Loop</p>	oleovera	535 320



Total thickness: approx. 18 mm
 Top layer thickness: approx. 3.5 mm
 Dimensions: 650 x 650 mm
 Packaging: 2 piece/pack
 Layer construction with plywood middle layer
 Installation system: Complete tongue and groove joints on all four sides for glue-down installation with flexible glue
 Bevel: on all four sides
 Finish: oleovera

Parquet Tile Design Central

Design		Finish	ID N°
	ASH ARABICA MEZZO Central	oleovera	535 321
	OAK Central	oleovera	535 322
	AFRICAN OAK Central	oleovera	535 323
	MERBAU Central	oleovera	535 324
	AMERICAN WALNUT Central	oleovera	535 325

Allegro Strip Parquet

The classic floor for versatile living

70 x 490 mm



- A timeless, classic design – Ideal for a wide variety of installation patterns, including herringbone
- Can be sanded

Finish:

Pm permaDur

nD naturaDur

n+ naturaLin plus

HARO PARQUET Allegro Strip Parquet

Top layer thickness:

for 3000 Series: approx. 2.5 mm with HDF-E1 coreboard

for 4000 Series: approx. 3.5 mm with solid wood base layer

for 6000 Series: approx. 5.4 mm with solid wood base layer

Surface layer dimensions: 70 x 490 mm

Total thickness: 9 mm (3000 Series)

10 mm (4000 Series)

12 mm (6000 Series)



HARO PARQUET 4000
Strip Allegro
OAK
Trend
in herringbone pattern





Dimensions: 9 x 70 x 490 mm
 Top layer thickness: approx.: 2.5 mm
 Packaging: 80 piece/pack = 2,74 m²
 30 pack/pallet = 82,2 m²
 7,66 kg/m²; 20,99 kg/pack;
 629,7 kg/pallet

Two-layer construction with special moisture-control
 HDF-E1 base layer for glue-down installation

STRIP ALLEGRO

PARQUET

3000 Series

Wood Species/Grade	Finish	ID N°
 OAK Light White Favorit brushed Matching skirting ID N° 409 614	<u>P_m</u>	536 369
 OAK ⁹ Favorit Matching skirting ID N° 406 922	<u>P_m</u>	536 370









Dimensions: 10 x 70 x 490 mm
 Top layer thickness: approx.: 3.5 mm
 Packaging: 72 piece/pack = 2,47 m²
 30 pack/pallet = 74,1 m²
 5,34 kg/m²; 13,19 kg/pack;
 395,7 kg/pallet
 2-layer construction with solid wood base layer
 for glue-down installation

STRIP ALLEGRO

PARQUET

4000 Series

Wood Species/Grade	Finish	ID N°
 OAK Light White Trend brushed Matching skirting ID N° 409 614	<u>P_m</u>	531 992
 OAK Puro White Trend brushed Matching skirting ID N° 409 613	<u>n+</u>	531 956
 OAK Invisible Trend brushed Matching skirting ID N° 409 733	<u>nD</u>	536 371
 OAK ² Exquisit Matching skirting ID N° 406 922	<u>P_m</u>	537 903
 OAK Trend Matching skirting ID N° P _m 406 922/n+ 406 890	<u>P_m</u> <u>n+</u>	537 906 531 958
 OAK Trend brushed Matching skirting ID N° 409 612	<u>nD</u>	536 372

Only delivered in complete cartons. HARO PARQUET with unfinished/sanded surface available on request; minimum purchasing quantity 200 m². Each carton contains 50% left and 50% right strips for regular or irregular bond patterns or herringbone. When laying the floor in a bond pattern, be careful to alternately lay a row of only left and a row of only right strips. Detailed laying instructions are included with every original carton.

² Delivery time on inquiry ⁹ Seasonal variations in grading possible.

Dimensions: 10 x 70 x 490 mm
 Top layer thickness: approx.: 3.5 mm
 Packaging: 72 piece/pack = 2,47 m²
 30 pack/pallet = 74,1 m²
 5,34 kg/m²; 13,19 kg/pack;
 395,7 kg/pallet

2-layer construction with solid wood base layer
 for glue-down installation



Wood Species/Grade		Finish	ID N°
	OAK Standard	<u>P_m</u>	537 904
		<u>n+</u>	531 959
Matching skirting ID N° Pm 406 922/n+ 406 890			
	OAK Terra	<u>P_m</u>	537 905
		<u>n+</u>	531 961
Matching skirting ID N° Pm 406 922/n+ 406 890			
	OAK^{2°} Tundra	<u>P_m</u>	537 907
Matching skirting ID N° 406 922			
	SMOKED OAK	<u>P_m</u>	537 902
		<u>n+</u>	531 962
Matching skirting ID N° Pm 406 932/n+ 406 893			
	AFRICAN OAK	<u>P_m</u>	537 901
		<u>n+</u>	531 963
Matching skirting ID N° Pm 406 933/n+ 406 894			
	BEECH STEAMED Trend	<u>P_m</u>	537 900
Matching skirting ID N° 406 923			
	CANADIAN MAPLE⁹ Favorit	<u>P_m</u>	537 899
Matching skirting ID N° 406 925			
	AMERICAN WALNUT Exquisit/Trend	<u>P_m</u>	537 910
Matching skirting ID N° 406 931			
	AMERICAN WALNUT Country	<u>P_m</u>	537 909
Matching skirting ID N° 406 931			
	AMBER ROBINIA⁹ Favorit	<u>P_m</u>	537 911
Matching skirting ID N° 406 937			

Only delivered in complete cartons. HARO PARQUET with unfinished/sanded surface available on request; minimum purchasing quantity 200 m². Each carton contains 50% left and 50% right strips for regular or irregular bond patterns or herringbone. When laying the floor in a bond pattern, be careful to alternately lay a row of only left and a row of only right strips. Detailed laying instructions are included with every original carton.
² Delivery time on inquiry² Seasonal variations in grading possible.



Dimensions: 10 x 70 x 490 mm
 Top layer thickness: approx.: 3.5 mm
 Packaging: 72 piece/pack = 2,47 m²
 30 pack/pallet = 74,1 m²
 5,34 kg/m²; 13,19 kg/pack;
 395,7 kg/pallet
 2-layer construction with solid wood base layer
 for glue-down installation

STRIP ALLEGRO

PARQUET

4000 Series

Wood Species/Grade	Finish	ID N°
 MERBAU¹	<u>Pm</u>	537 908
Matching skirting ID N° 406 930		



Dimensions: 12 x 70 x 490 mm
 Top layer thickness: approx.: 5.4 mm
 Packaging: 60 piece/pack = 2,06 m²
 30 pack/pallet = 61,8 m²
 5,8 kg/m²; 11,95 kg/pack;
 358,5 kg/pallet

STRIP ALLEGRO

PARQUET

6000 Series

all prices in € /m²

Wood Species/Grade	Finish	ID N°
NEW  OAK^{2,9} Trend brushed	<u>Pm</u>	537 840
Matching skirting ID N° 406 922		

Only delivered in complete cartons. HARO PARQUET with unfinished/sanded surface available on request; minimum purchasing quantity 200 m². Each carton contains 50% left and 50% right strips for regular or irregular bond patterns or herringbone. When laying the floor in a bond pattern, be careful to alternately lay a row of only left and a row of only right strips. Detailed laying instructions are included with every original carton.

¹ See note on exotic woods on page 12 ² Delivery time on inquiry ⁹ Seasonal variations in grading possible.

Prestige Strip Parquet

Timeless and unique

120 x 1000 mm



- Compact Plank 1-Strip format – ideal for making small rooms look larger
- Also suitable for installation in the bathroom and kitchen area when following special installation and finishing instructions.
- Convinces by its variety of installation options - even as a herringbone pattern
- Can be sanded

HARO PARQUET Prestige Strip Parquet

Top layer thickness: approx. 3,5 mm
Surface layer dimensions: 120 x 1000mm
Total thickness: 10 mm

Finish:

nD naturaDur

n+ naturaLin plus



HARO PARQUET 4000
Strip Prestige
AFRICAN OAK
MARKANT











Dimensions: 10 x 120 x 1000 mm
 Top layer thickness: approx.: 3.5 mm
 Packaging: 26 piece/pack = 3,12 m²
 18 pack/pallet = 56,16 m²
 5,34 kg/m²; 16,66 kg/pack;
 299,88 kg/pallet
 2-layer construction with solid wood base layer
 for glue-down installation

STRIP PRESTIGE

PARQUET

4000 Series

Wood Species/Grade		Finish	ID N°
	OAK Puro White Markant brushed	<u>n+</u>	530 368
	Matching skirting ID N° 409 613		
	OAK Invisible Markant brushed	<u>nD</u>	536 374
	Matching skirting ID N° 409 733		
	OAK⁴ Markant	<u>n+</u>	530 365
	Matching skirting ID N° 406 890		
	OAK Markant brushed	<u>nD</u>	536 375
	Matching skirting ID N° 409 612		
	OAK⁵ Sauvage	<u>n+</u>	536 377
	Matching skirting ID N° 406 890		
	OAK⁵ Sauvage brushed	<u>nD</u>	536 376
	Matching skirting ID N° 409 612		
	SMOKED OAK⁴ Markant	<u>n+</u>	530 371
	Matching skirting ID N° 406 893		
	AFRICAN OAK⁴ Markant	<u>n+</u>	530 376
	Matching skirting ID N° 406 894		

STRIP PARQUET

Only delivered in complete cartons. HARO PARQUET with unfinished/sanded surface available on request; minimum purchasing quantity 200 m². Each carton contains 50% left and 50% right strips for regular or irregular bond patterns or herringbone. When laying the floor in a bond pattern, be careful to alternately lay a row of only left and a row of only right strips. Detailed laying instructions are included with every original carton.

⁴ Special laying instructions for bathroom installation must be followed! ⁵ Splinters and core splits may form on the board surface.

Strip Plank Scala

Authentic comfort

160 x 1750 mm

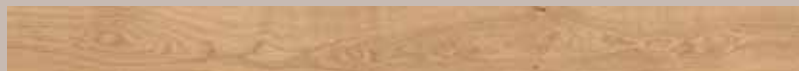

- Large, elegant format – creates a well-balanced, spacious effect.
- Can be sanded

HARO PARQUET Strip Plank Scala

Top layer thickness: approx. 3,5 mm
Surface layer dimensions: 160 x 1750 mm
Total thickness: 10 mm

Finish:

nD naturaDur

n+ naturaLin plus



HARO PARQUET 4000
Strip Plank Scala
OAK INVISIBLE
SAUVAGE
brushed 2V







Dimensions: 10 x 160 x 1750 mm
 Top layer thickness: approx.: 3.5 mm
 Packaging: 13 piece/pack = 3,64 m²
 28 pack/pallet = 101,92 m²
 5,34 kg/m²; 19,44 kg/pack;
 544,32 kg/pallet

STRIP PLANK SCALA

PARQUET

4000 Series

2-ply construction with solid wood base layer for glue-down installation

Wood Species/Grade		Finish	ID N°
	OAK Puro White Markant brushed 2V	<u>n+</u>	529 179
	Matching skirting ID N° 409 613		
	OAK⁵ Invisible Sauvage brushed 2V	<u>n+</u>	536 378
	Matching skirting ID N° 409 733		
	OAK Markant brushed 2V	<u>nD</u> <u>n+</u>	536 379 529 177
	Matching skirting ID N° 409 612		
	OAK⁵ Sauvage brushed 2V	<u>nD</u> <u>n+</u>	536 380 529 401
	Matching skirting ID N° 409 612		
	SMOKED OAK Markant brushed 2V	<u>n+</u>	529 181
	Matching skirting ID N° 409 611		

STRIP PARQUET

Strip Plank Maxim

The perfect cast for a high-class look

180 x 2200 mm



- Very trendy in original plank 1-strip format
- Tongue-and-groove joint ,plus' with insertion aid/guide / introducer for fast installation
- Can be sanded

HARO PARQUET Strip Plank Maxim

Top layer thickness: approx. 3,5 mm
Surface layer dimensions: 180 x 2200 mm
Total thickness: 10,5 mm

Finish:

nD naturaDur

n+ naturaLin plus



HARO PARQUET
Strip Plank Maxim
OAK
SAUVAGE
brushed 4V













Dimensions: 10.5 x 180 x 2200 mm
 Top layer thickness: approx.: 3.5 mm
 Packaging: 6 piece/pack = 2,38 m²
 32 pack/pallet = 76,16 m²
 9,02 kg/m²; 21,47 kg/pack;
 687,04 kg/pallet

STRIP PLANK MAXIM

PARQUET

4000 Series

2-layer construction with special moisture-control
 HDF-E1 coreboard for glue-down installation





Wood Species/Grade		Finish	ID N°
	OAK Sand White Markant brushed 2V	<u>nD</u>	536 381
	Matching skirting ID N° 409 789		
	OAK⁵ Sand White Sauvage brushed 2V	<u>nD</u>	536 382
	Matching skirting ID N° 409 789		
	OAK Puro White Markant brushed 4V	<u>n+</u>	532 264
	Matching skirting ID N° 409 613		
	OAK⁵ Puro White Sauvage brushed 4V	<u>n+</u>	532 266
	Matching skirting ID N° 409 613		
	OAK Invisible Markant brushed 2V	<u>nD</u>	536 383
	Matching skirting ID N° 409 733		
	OAK⁵ Invisible Sauvage brushed 2V	<u>nD</u>	536 384
	Matching skirting ID N° 409 733		
	OAK Markant brushed 2V	<u>nD</u>	536 385
	Matching skirting ID N° 409 612		
	OAK Markant brushed 4V	<u>n+</u>	532 260
	Matching skirting ID N° 409 612		
	OAK⁵ Sauvage brushed 2V	<u>nD</u>	536 386
	Matching skirting ID N° 409 612		
	OAK⁵ Sauvage brushed 4V	<u>n+</u>	532 262
	Matching skirting ID N° 409 612		

STRIP PARQUET

Dimensions: 10.5 x 180 x 2200 mm
 Top layer thickness: approx.: 3.5 mm
 Packaging: 6 piece/pack = 2,38 m²
 32 pack/pallet = 76,16 m²
 9,02 kg/m²; 21,47 kg/pack;
 687,04 kg/pallet

2-layer construction with special moisture-control
 HDF-E1 coreboard for glue-down installation



Wood Species/Grade		Finish	ID N°
	OAK Sand Grey Markant brushed 2V Matching skirting ID N° 409 785	<u>nD</u>	536 387
	OAK⁵ Sand Grey Sauvage brushed 2V Matching skirting ID N° 409 785	<u>nD</u>	536 388
	SMOKED OAK⁶ Markant brushed 2V Matching skirting ID N° 409 611	<u>n+</u>	536 389
	SMOKED OAK^{5 6} Sauvage brushed 4V Matching skirting ID N° 409 611	<u>n+</u>	536 390

Only delivered in complete cartons. HARO PARQUET with unfinished/sanded surface available on request; minimum purchasing quantity 200 sq.m.
 We reserve the right to supply one layer per carton in lengths below 2 m.

⁵ Splinters and core splits may form on the board surface.

⁶ Dimensions: 10.5 x 173 x 2200 mm, Packaging: 6 piece/pack = 2,28 m² 32 pack/pallet = 72,96 m² 9,02 kg/m²; 20,57 kg/pack; 658,1 kg/pallet



HARO PARQUET
Strip Plank Maxim
OAK PURO WHITE
MARKANT
brushed 4V



Your direct link to the HARO website

HARO Laminate Floor – simply better

The laminate floor with the most beautiful wood reproductions

Germany's leading parquet specialist offers you Laminate Floors with perfect wood styles and authentic surfaces that are almost indistinguishable from the original. With the selection of different designs such as the trendy Gran Via long board, we offer a product range that will create a 'wow' effect in any home.

The world's quietest laminate floor

Expertise creates that perfect look, innovations provide added comfort, and Tritty Silent CT brings peace and quiet to your home. We can offer you the world's quietest laminate floor – equipped with our ComforTec technology, it reduces room sound by an amazing 60%.

One of the easiest to install laminate floors

To make our floors not only look good, but also easy to install, we have equipped them with the Top Connect installation system. Probably the world's easiest installation system.

HARO Laminate Floor offers you more:

- Brand quality – Made in Germany
- The most beautiful wood styles from the parquet specialist
- Great choice with 6 designs and 8 different textures
- Awarded the Blue Angel label
- Easy to install with Top Connect
- High-quality engineering
- Warranty up to 25 years
- Excellent price/performance ratio
- Optional integrated sound insulation
- Outstanding visual impact
- Dimensionally stable and high precision fit
- Suitable for use with underfloor heating and cooling
- Antistatic (ASFL class)
- Largely scratch resistant
- Resistant to fading under UV light
- Dirt-repellent and easy to maintain
- Double moisture protection with aquaTec system
- Abrasion resistant
- Hardly inflammable (Cfl-S1), tested in acc. with DIN EN 13501-1
- Impact and dent resistant
- Resistant to cigarette burn marks
- also for damp areas (Tritty 200 Aqua)



Formats

Every room has its own unique character – and every person has individual needs and requirements. So it's great that HARO Laminate Floor offers six different board formats that make every interior design dream come true: from the classical Plank 1-Strip look to the trendy Gran Via format we provide more selection for less compromise.

3-Strip

Also known as longstrip. Special feature: each floorboard is composed of three parallel strips.
Board dimensions: 193 x 1282 mm

2-Strip

The clear one. Individuality of the wood reproduction is given more room to radiate its clear vibrancy.
Board dimensions: 193 x 1282 mm

Plank 1-Strip

The classic one. Particularly popular because of its spacious visual impact.
Board dimensions: 193 x 1282 mm

Loft 4V

The slim one. The slender format and the bevelled edge on four sides emphasise the „plank“ character.
Dielenabmessung: 135 x 1282 mm

Campus 4V

The trendy one. Campus is a successful combination of classical board length and generous width – with a bevelled edge on four sides.
Board dimensions: 243 x 1282 mm

Gran Via 4V

The gigantic one. Shows form and gives that spacious effect everywhere. The special length and the bevelled edge on four sides put even more emphasis on the plank characteristic.
Board dimensions: 243 x 2200 mm



Structure and areas of use

Construction HARO Special Edition NKL 31, HARO TRITTY 90, HARO TRITTY 100

1. Overlay, specially impregnated (durable protective layer)
2. Decorative laminate, specially impregnated
3. Dimensionally stable, special moisture control HDF E1 coreboard aquaResist
4. Moisture-repellent balancing laminat
5. Optionally available with integrated Silent Pro luxury insulation layer or with Silent CT technology (suitable for use with underfloor heating)



Construction HARO TRITTY 200 Aqua

1. Overlay, specially impregnated (durable protective layer)
2. Decorative laminate, specially impregnated
3. The dimensionally stable AquaReject coreboard is also approved for use in damp rooms in accordance with W0-1 (DIN 18534), such as domestic bathrooms or kitchens, due to the highest possible swelling resistance.
4. Moisture-repellent balancing laminat
5. Optionally available with integrated Silent Pro luxury insulation layer or with Silent CT technology (suitable for use with underfloor heating)



Recommended areas of use

The table will tell you which floor is best for which application

Special Edition NKL 31



For residential applications with high traffic and commercial applications with low traffic

TRITTY 90



For residential applications with high traffic and commercial applications with medium level traffic

TRITTY 100



For residential applications with high traffic and commercial applications with medium level traffic

TRITTY 200 Aqua



For residential applications and high traffic commercial applications

Residential



Commercial





	Special Edition NKL 31	TRITTY 90	TRITTY 100	TRITTY 200 Aqua
Bedroom	recommended	recommended	recommended	recommended
Children's room	recommended	recommended	recommended	recommended
Dining room	recommended	recommended	recommended	recommended
Living room	recommended	recommended	recommended	recommended
Corridor	possible	recommended	recommended	recommended
Kitchen	possible	recommended	recommended	recommended
Office		recommended	recommended	recommended
Hotel room		recommended	recommended	recommended
Conference room		recommended	recommended	recommended
Doctor's practice		possible	possible	recommended
Reception area				recommended
Sales area				recommended





recommended possible





Series

Technical construction

 Special Edition NKL 31	Dimensions	Level of use	Abrasion class	Warranty	Silent Pro
	7 x 193 x 1282 mm	23/31 	AC3	15 years for resid. applications	2 mm thick
	9 x 193 x 1282 mm	Room sound improvement: approx. 30%*, Footfall sound reduction: 18 dB			
	Impact class IC1	Scratch resistance Grade 3			

 HARO TRITTY 90	Dimensions	Level of use	Abrasion class	Warranty	Silent Pro
	7 x 193 x 1282 mm	23/32 	AC4	20 years in resid. applications 5 years in comm. applications	2 mm thick
	9 x 193 x 1282 mm	Room sound improvement: approx. 30%*, Footfall sound reduction: 18 dB			
	9 x 193 x 1282 mm	Room sound improvement: approx. 60%*, Footfall sound reduction: 14 dB			
	Impact class IC1	Scratch resistance Grade 4	Antistatic class: ASF2		

 HARO TRITTY 100	Dimensions	Level of use	Abrasion class	Warranty	Silent Pro
Plank 1-Strip, 3-Strip	8 x 193 x 1282 mm				
Loft 4V	8 x 135 x 1282 mm				
Campus 4V	8 x 243 x 1282 mm				
Gran Via 4V	8 x 243 x 2200 mm				
		23/32 	AC4	25 years in resid. applications 5 years in comm. applications	2 mm thick
	2 mm higher	Room sound improvement: approx. 30%*, Footfall sound reduction: 18 dB			
	2 mm higher	Room sound improvement: approx. 60%*, Footfall sound reduction: 14 dB			
	Impact class IC2	Scratch resistance Grade 4	Antistatic class ASF2		

 HARO TRITTY 200 Aqua	Dimensions	Level of use	Abrasion class	Warranty	Silent Pro
Plank 1-Strip	8 x 193 x 1282 mm				
Gran Via 4V	8 x 243 x 2200 mm				
		23/33 	AC6	25 years in resid. applications 10 years in comm. applications	2 mm thick
	2 mm higher	Room sound improvement: approx. 30%*, Footfall sound reduction: 18 dB			
	2 mm higher	Room sound improvement: approx. 60%*, Footfall sound reduction: 14 dB			
	Impact class IC3	Scratch resistance Grad 5	Antistatic class ASF2		



5G Fold Down locking system

Moisture protection

aquaTec – Double moisture protection

Their well-balanced multilayer construction ensures that HARO Laminate Floors remain stable at all times. And the special aquaTec system gives you the guarantee that they will always stay in good shape. This is achieved by connecting the aquaResist special moisture control HDF coreboard with a specially impregnated protective coat (overlay and style). TRITTY 200 Aqua uses the special aquaReject coreboard, which allows installation even in damp rooms.

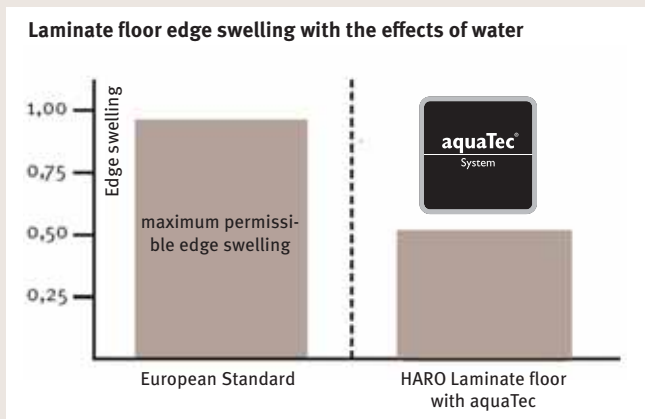

TRITTY 200 AQUA – also for damp areas



The new TRITTY 200 Aqua Series offers additional security.

Due to the moisture-control aquaReject coreboard, the floor is optimally protected against moisture and also approved for installation in damp rooms * (W0-1 in accordance with DIN 18534), such as domestic bathrooms or kitchens. Due to its special impregnation and the highest degree of resistance against swelling, TRITTY 200 Aqua can withstand standing tap water for up to 4 hours.

Thanks to the high utilisation class 23/33, the floor is also ideally suitable for areas subject to particularly heavy wear, such as the hall or the kitchen.

- It is not suitable for installation in wet areas such as bathrooms or saunas.
- Please note: The subfloor moisture must comply with the standard specifications for installation.
- The installation instructions must always be followed carefully.

Surfaces

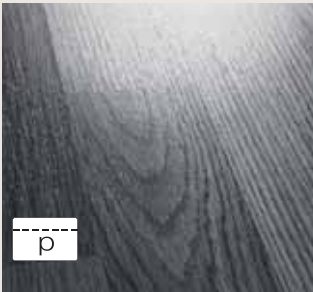

Pores
Slightly pore-textured and silky shine finish.

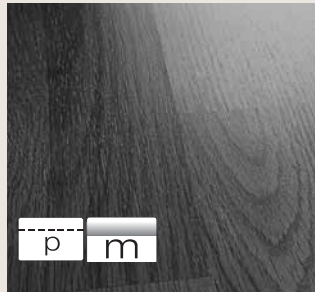

Pores matt
Slightly pore-textured and natural elegant look.

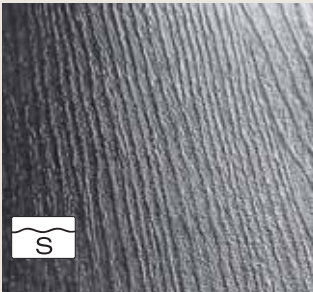

Brushed
With the feel of real wood grain.

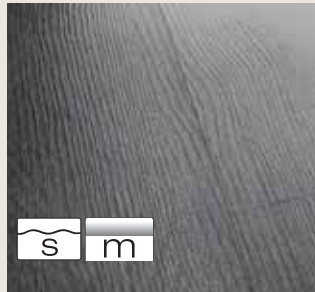

Textured matt
Similar to real wood grain. The matt appearance underlines the natural look.



Soft matt
Distinctive velvety soft surface. Natural and matt with a slight gloss effect in the texture.

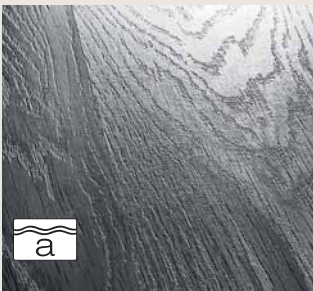

Authentic
Almost indistinguishable from real wood. Texture and style match perfectly. The gloss level emphasises the character and the natural look of the wood reproduction.

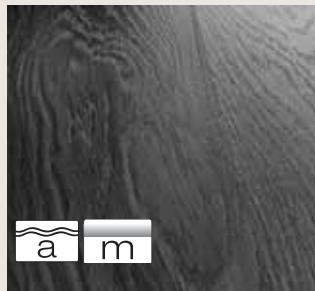

Authentic matt
Almost indistinguishable from real wood. Texture and style match perfectly. The surface has a natural oil character. The Plank 1-Strip designs also have a slight shine effect in the pores.



Authentic soft
Almost indistinguishable from real wood. Texture and style match perfectly. The surface feels velvety and soft.



Bevelled edge on the long and short sides
The edges are chamfered on both sides and the ends – for an even more vivid and authentic effect. The experts call this “long and short side beveling”.

Installation

Care

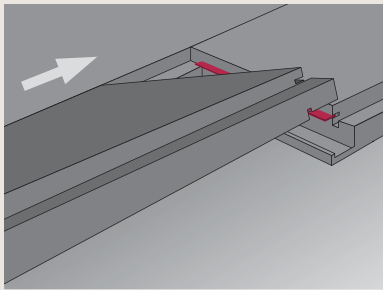

Angle in

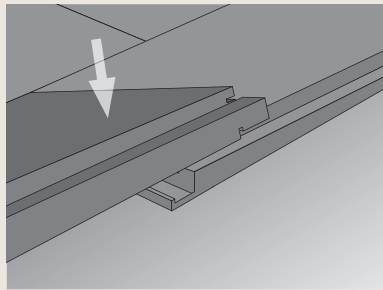

Press down

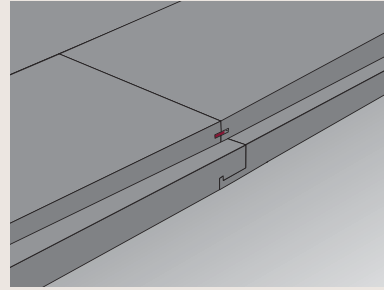

Finished

Top Connect is one of the world's easiest installation systems. The boards are angled in at the long sides and interlocked at the short sides with a small amount of pressure. The floor is not only easy to put in, it is just as easy to take out when you move.

- No tools required
- Very quick to install
- High-precision system
- Easy to put in – easy to take out
- Safe and secure connections on the short and long sides



Fold Down locking system

HARO TRITTY Laminate Floors are very easy to maintain.

For all our floors we offer special cleaning and care products developed to ensure that you can enjoy your HARO Laminate Floor for a very long time. For more information about cleaning and care see page 192.



clean & green[®]
Quick, easy and natural maintenance of all floors

HARO TRITTY Silent CT – the quietest laminate floor

60% quieter than standard floating laminate floors



ComforTec

(self-adhesive strips on the underside of the boards)

THE REVOLUTION

60% quieter than standard floating laminate floors

Forget about annoying stomping, heel clacking and drum sound effects. Enjoy the peace and quiet of the world's quietest laminate floor. This is the result of HARO's ComforTec innovation. Self-adhesive strips on the underside of the boards make the glue-down installation with the subfloor possible. The outcome: Walk with the pleasant acoustic of a full glue-down floor. But this innovative laminate floor can do more than sound good. HARO TRITTY Silent CT is durable and easy to maintain, offers perfect wood reproductions created by the parquet specialists, and is blindingly easy to install with Top Connect.

We offer you the following key benefits:

- Reduces room sound by sensational 60% (compared to standard laminate floors with insulation)
- Is just as affordable but audibly better than laminate floor with a high-quality insulation underlay purchased separately
- Easy to install with Top Connect
- Self-adhesive strips on the underside of each board allow firm gluing of the boards to the subfloor
- Installs without glue or pollutant emissions
- Ready to "live on" immediately
- Provides highest durability with up to 25 years warranty
- Available on request in the Series TRITTY 90, TRITTY 100, TRITTY 200 Aqua.

Items on stock can be identified by the item number printed in black.

Red product numbers indicate items that are not in stock. Delivery time on inquiry.

For more information about HARO TRITTY Silent CT, visit our website at www.haro.com



Your direct link to the HARO website

up to



Fold Down locking system



Most beautiful styles
+ Easiest installation
+ Quietest laminate floor
= HARO TRITTY Silent CT

Audibly quieter – as independent sound level tests confirm.

Test certificates for "EPLF Impact Hammer" and "IHD - Walking Lady"*

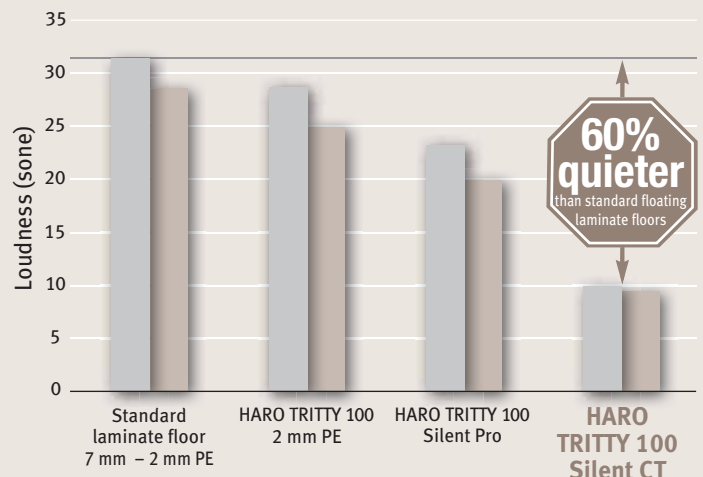

EPLF Impact Hammer IHD Walking Lady

* Tested and certified by the Notified Body: Entwicklungs- und Prüflabor Holztechnologie GmbH in Dresden, Germany

Measurement of the reflected footfall EPLF WD 021029-5 „Impact hammer“ / IHD work standard 438 „Walking on“

Insulation Underlays Silent Pro – for added soundproofing, resilience and comfort



We recommend an insulation underlay for all hard subfloors. They help to increase resilience, absorb indoor and footfall sound, and level minor irregularities of the subfloor. Thanks to the high elasticity provided by the mineral fillers, the Silent Pro insulation creates a pleasant “forest floor effect” and reduces strain on body joints and spine. Silent Pro is also suitable for installation over underfloor heating. And the best of it: With a Silent Pro insulation layer fitted to the board underside, you not only save a whole work step, but also ensure optimal acoustic properties.



Pleasant for you when the sound level in the room is perceptibly minimised.

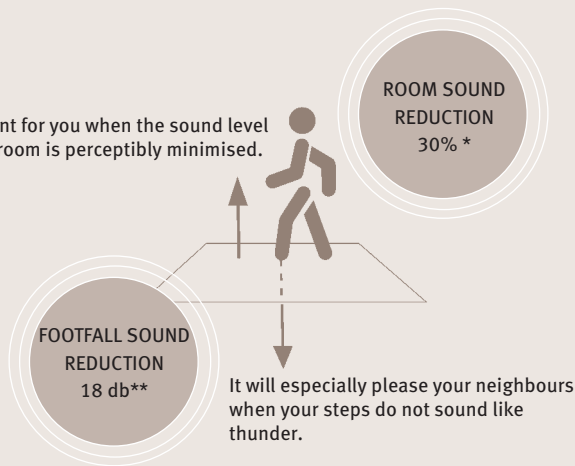

* Maximum individual values achieved in accordance with the EPLF Impact Hammer test (compared to reference floor)

** According to DIN 140-8

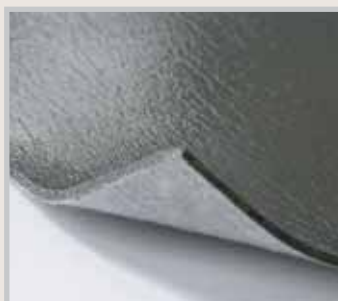

All laminate floor products printed with **black product numbers** in the price list are stock items. **All other product numbers in red are not on stock. Delivery time on inquiry.**

And for those who prefer roll goods:
Silent Pro insulation underlay is also available
in rolls in the HARO Accessories range

HARO Laminate Floor Special Edition NKL 31

The perfect starter

Level of use: 23/31
Abrasion class: AC3
Thickness: 7 mm (with Silent Pro 9 mm)
Dimensions: 193 x 1282 mm

Suitable for use with underfloor heating and cooling

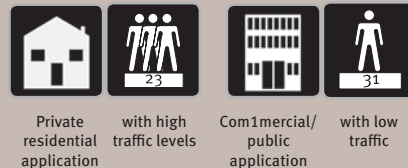

optional:
Silent Pro
Insulation underlay

Antistatic class
ASF2



www.blauer-engel.de/uz176



HARO Special Edition NKL 31
Plank 1-Strip
OAK MERAN
textured matt
(wood reproduction)





















Level of use: 23/31
 Abrasion class: AC3
 Thickness: 7 mm
 Thickness with Silent Pro: 9 mm
 Dimensions: 193 x 1282 mm

Every product printed in red ordered in a minimum quantity of 10 sq.m. is optionally also available with Silent Pro (delivery time on inquiry).

Special Edition NKL 31	Special Edition NKL 31 Silent Pro
0,247 m ² /Element	0,247 m ² /Element
9 piece/pack = 2,22 m ²	7 piece/pack = 1,73 m ²
52 pack/pallet = 115,44 m ²	52 pack/pallet = 89,96 m ²
6,41 kg/m ²	8,31 kg/m ²
14,23 kg/pack	14,38 kg/pack
739,96 kg/pallet	747,76 kg/pallet



Design/Style	Insulation	ID N°
 soft m	Plank 1-Strip OAK SIENA¹ Velvet White Matching skirting ID N° 410 770	538 634  538 641 ²
 soft m	Plank 1-Strip OAK TIVOLI¹ Matching skirting ID N° 410 766	538 629  538 636 ²
 s m	Plank 1-Strip OAK DOVER¹ Matching skirting ID N° 409 319	534 267  536 052 ²
 s m	2-Strip GRAPHITE OAK¹ Matching skirting ID N° 408 593	530 278  536 055 ²
 p	3-Strip BEECH BEIGE¹ Matching skirting ID N° 408 614	538 630  538 637 ²
 p	3-Strip MAPLE AKZENT¹ Matching skirting ID N° 406 821	538 631  538 638 ²
 soft m	Plank 1-Strip OAK SIENA¹ Puro Matching skirting ID N° 410 769	538 632  538 639 ²
 soft m	Plank 1-Strip OAK OLBIA¹ Matching skirting ID N° 410 755	538 628  538 635 ²
 s m	2-Strip OAK ENGADIN¹ Matching skirting ID N° 409 317	533 098  536 053 ²

Packaging in carton and film. Only delivered in complete cartons.

1) Wood reproduction

2) Not within the stock range; product line order (minimum purchasing quantity: 10 sq.m). Delivery time on inquiry.











Level of use: 23/31
 Abrasion class: AC3
 Thickness: 7 mm
 Thickness with Silent Pro: 9 mm
 Dimensions: 193 x 1282 mm

Every product printed in red ordered in a minimum quantity of 10 sq.m. is optionally also available with Silent Pro (delivery time on inquiry).

Special Edition NKL 31	Special Edition NKL 31 Silent Pro
0,247 m ² /Element	0,247 m ² /Element
9 piece/pack = 2,22 m ²	7 piece/pack = 1,73 m ²
52 pack/pallet = 115,44 m ²	52 pack/pallet = 89,96 m ²
6,41 kg/m ²	8,31 kg/m ²
14,23 kg/pack	14,38 kg/pack
739,96 kg/pallet	747,76 kg/pallet



Design/Style	Insulation	ID N°
 	Plank 1-Strip OAK MERAN¹ 	535 201 536 054 ²
NEW  	Plank 1-Strip OAK MODENA¹ 	538 633 538 640 ²
NEW  	3-Strip WALNUT AMBIENTE¹ 	538 854 538 642 ²



HARO Special Edition NKL 31
2-Strip
GRAPHITE OAK
textured/matt
(wood reproduction)

HARO Laminate Floor TRITTY 90

Trendy floor design – beautiful and durable

Level of use: 23/32

Antistatic class: ASF2

Abrasion class: AC4

Thickness: 7 mm (with Silent Pro/Silent CT 9 mm)

Dimensions: 193 x 1282 mm



Private residential application



with high traffic levels



Commercial/public application



medium traffic level

Suitable for use with underfloor heating and cooling



optional:
Silent Pro
insulation layer



optional:
Silent CT
(ComforTec)
technology



Antistatic
class
ASF2



HARO TRITTY 90
Plank 1-Strip 4V
SCANDINAVIAN OAK
authentic
(wood reproduction)



Fold Down
locking system



Level of use: 23/32

Abrasion class: AC4

Thickness: 7 mm

Thickness with Silent Pro/Silent CT: 9 mm

















Dimensions: 193 x 1282 mm

Every product printed in red ordered in a minimum quantity of 10 sq.m. is optionally also available with Silent CT or Silent Pro (delivery time on inquiry).

All Laminate Floor products with a Silent Pro or Silent CT product number printed in black in the price list are stock items.

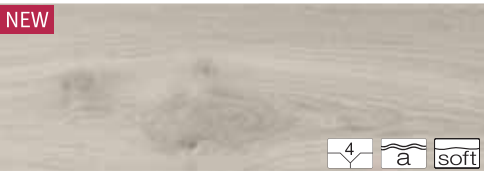
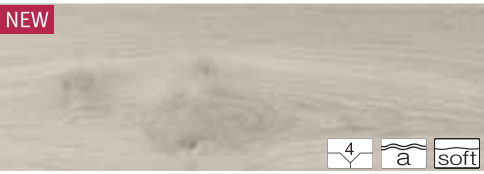

TRITTY 90	TRITTY 90 Silent Pro	TRITTY 90 Silent CT
0,247 m ² /Element	0,247 m ² /Element	0,247 m ² /Element
9 piece/pack = 2,22 m ²	7 piece/pack = 1,73 m ²	7 piece/pack = 1,73 m ²
52 pack/pallet = 115,44 m ²	52 pack/pallet = 89,96 m ²	24 pack/pallet = 41,52 m ²
6,41 kg/m ²	8,31 kg/m ²	6,41 kg/m ²
14,23 kg/pack	14,38 kg/pack	11,09 kg/pack
739,96 kg/pallet	747,76 kg/pallet	266,16 kg/pallet

Design/Style	Insulation	ID N°
 <p>NEW</p> <p>Plank 1-Strip 4V OAK SAVONA¹ White</p> <p>Matching skirting ID N° 410 757</p>		538 648
	Silent Pro	538 661 ²
 <p>Silent CT</p> <td>538 678²</td>	538 678 ²	
	 <p>Plank 1-Strip 4V SCANDINAVIAN OAK</p> <p>Matching skirting ID N° 409 809</p>	
Silent Pro		535 243 ²
 <p>Silent CT</p> <td>535 251²</td>	535 251 ²	
	 <p>NEW</p> <p>Plank 1-Strip 4V OAK BERGAMO¹ Antique White</p> <p>Matching skirting ID N° 410 759</p>	
Silent Pro		538 659 ²
 <p>Silent CT</p> <td>538 676²</td>	538 676 ²	
	 <p>NEW</p> <p>Plank 1-Strip HIGHLAND OAK¹</p> <p>Matching skirting ID N° 407 815</p>	
Silent Pro		538 674
 <p>Silent CT</p> <td>538 688</td>	538 688	
	 <p>Plank 1-Strip 4V DESIGN WOOD HARMONY¹</p> <p>Matching skirting ID N° 409 813</p>	
Silent Pro		535 245 ²
 <p>Silent CT</p> <td>535 253²</td>	535 253 ²	
	 <p>NEW</p> <p>Plank 1-Strip 4V OAK DOLOMITI¹</p> <p>Matching skirting ID N° 408 605</p>	
Silent Pro		538 670 ²
 <p>Silent CT</p> <td>538 684²</td>	538 684 ²	
	 <p>NEW</p> <p>Plank 1-Strip 4V OAK EMILIA¹ Light Grey</p> <p>Matching skirting ID N° 410 761</p>	
Silent Pro		538 667
 <p>Silent CT</p> <td>538 681</td>	538 681	
	 <p>NEW</p> <p>Plank 1-Strip 4V OAK LIVORNO¹ Greige</p> <p>Matching skirting ID N° 409 319</p>	
Silent Pro		538 668 ²
 <p>Silent CT</p> <td>538 682²</td>	538 682 ²	
	 <p>Plank 1-Strip 4V OAK MELINA¹ Puro</p> <p>Matching skirting ID N° 409 814</p>	
Silent Pro		535 246
 <p>Silent CT</p> <td>535 254</td>	535 254	

Packaging in carton and film. Only delivered in complete packs.

1) Wood reproduction

2) Not within the stock range; product line order (minimum purchasing quantity: 10 sq.m). Delivery time on inquiry.

Level of use: 23/32
 Abrasion class: AC4
 Thickness: 7 mm
 Thickness with Silent Pro/Silent CT: 9 mm
 Dimensions: 193 x 1282 mm











Every product printed in red ordered in a minimum quantity of 10 sq.m. is optionally also available with Silent CT or Silent Pro (delivery time on inquiry).

All Laminate Floor products with a Silent Pro or Silent CT product number printed in black in the price list are stock items.



TRITTY 90	TRITTY 90 Silent Pro	TRITTY 90 Silent CT
0,247 m ² /Element	0,247 m ² /Element	0,247 m ² /Element
9 piece/pack = 2,22 m ²	7 piece/pack = 1,73 m ²	7 piece/pack = 1,73 m ²
52 pack/pallet = 115,44 m ²	52 pack/pallet = 89,96 m ²	24 pack/pallet = 41,52 m ²
6,41 kg/m ²	8,31 kg/m ²	6,41 kg/m ²
14,23 kg/pack	14,38 kg/pack	11,09 kg/pack
739,96 kg/pallet	747,76 kg/pallet	266,16 kg/pallet

Design/Style	Insulation	ID N°
 <p>3-Strip HOLM OAK¹</p> <p>Matching skirting ID N° 406 847</p>		538 855
	Silent Pro	538 673
 <p>Plank 1-Strip 4V OAK ITALICA¹ Creme</p> <p>Matching skirting ID N° 408 608</p>		538 653
	Silent Pro	538 669
 <p>Plank 1-Strip 4V OAK VERANO¹</p> <p>Matching skirting ID N° 409 317</p>		538 655
	Silent Pro	538 671
 <p>Plank 1-Strip 4V OAK SAVONA¹ Nature</p> <p>Matching skirting ID N° 410 756</p>		538 649
	Silent Pro	538 665
 <p>Plank 1-Strip 4V OAK TERANA¹</p> <p>Matching skirting ID N° 408 618</p>		535 239
	Silent Pro	535 247 ²
 <p>Plank 1-Strip 4V OAK LIVORNO¹ Smoked</p> <p>Matching skirting ID N° 410 768</p>		538 650
	Silent Pro	538 666 ²
 <p>Plank 1-Strip 4V OAK CORONA¹</p> <p>Matching skirting ID N° 409 808</p>		538 645
	Silent Pro	538 657
 <p>Plank 1-Strip ALABAMA OAK¹</p> <p>Matching skirting ID N° 406 818</p>		538 647
	Silent Pro	538 660 ²
 <p>Plank 1-Strip 4V OAK¹ smoked</p> <p>Matching skirting ID N° 409 183</p>		538 656
	Silent Pro	538 672 ²
	Silent CT	538 677 ²
	Silent CT	538 686 ²

Packaging in carton and film. Only delivered in complete packs.

1) Wood reproduction

2) Not within the stock range; product line order (minimum purchasing quantity: 10 sq.m). Delivery time on inquiry.

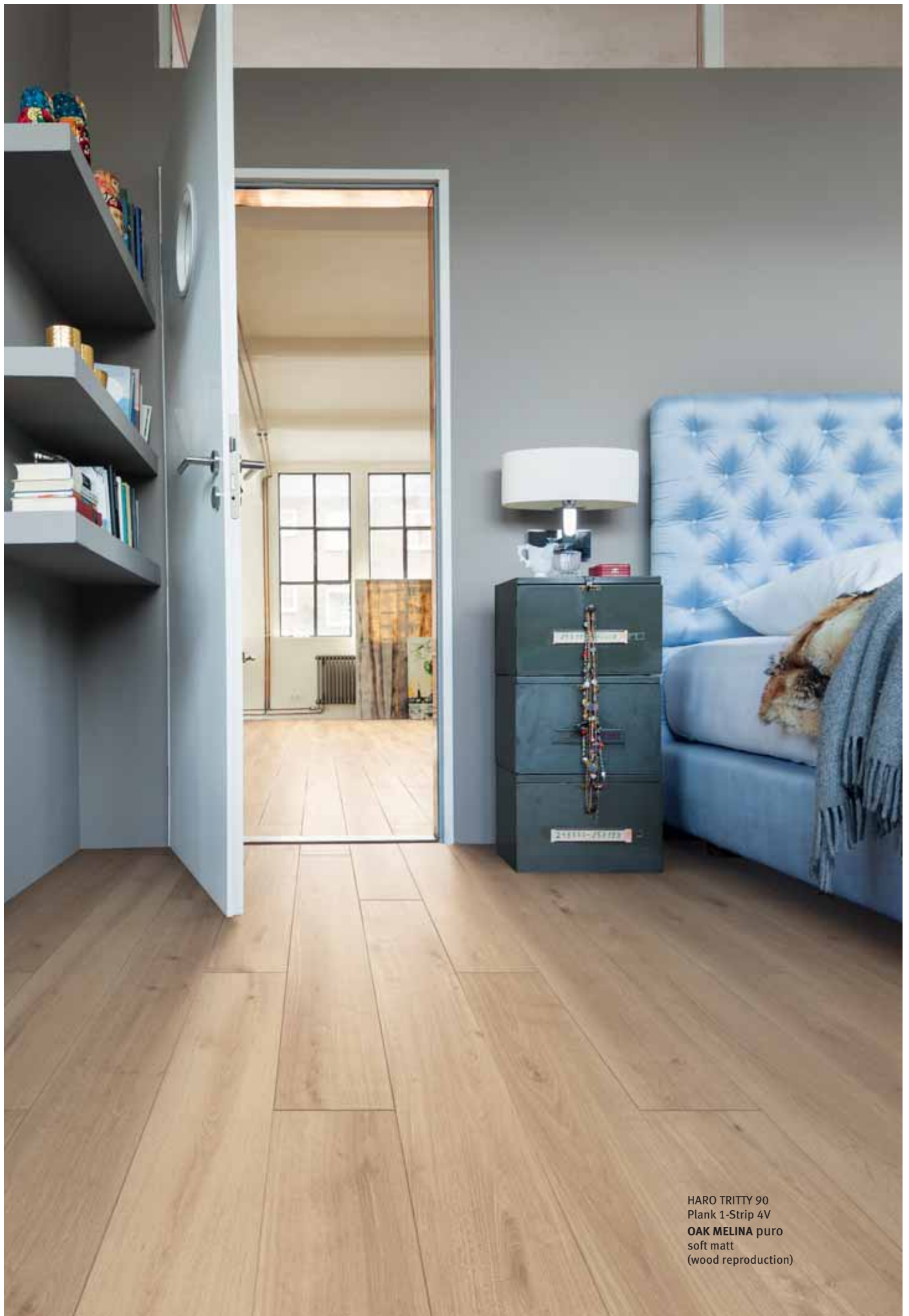

HARO TRITTY 90
Plank 1-Strip 4V
OAK MELINA puro
soft matt
(wood reproduction)

HARO Laminate Floor TRITTY 100

The tough laminate floor with the huge choice

Level of use: 23/32

Antistatic class: ASF2

Abrasion class: AC4

Thickness: 8 mm (with Silent Pro/Silent CT 10 mm)

Dimensions: 193 x 1282 mm



Private residential application



with high traffic levels



Commercial/public application



medium traffic level

Suitable for use with underfloor heating and cooling



optional:
Silent Pro insulation layer

optional:
Silent CT (ComforTec) technology

Antistatic class
ASF2

HARO TRITTY 100
Plank 1-Strip 4V
OAK ITALICA Nature
authentic
(wood reproduction)





Level of use: 23/32

Abrasion class: AC4

Thickness: 8 mm

Thickness with Silent Pro/Silent CT: 10 mm

Dimensions: 193 x 1282 mm

Plank 1-Strip/3-Strip

Every product printed in red ordered in a minimum quantity of 10 sq.m. is optionally also available with Silent CT or Silent Pro (delivery time on inquiry).

All Laminate Floor products with a Silent Pro or Silent CT product number printed in black in the price list are stock items.



TRITTY 100	TRITTY 100 Silent Pro	TRITTY 100 Silent CT
0,247 m ² /Element	0,247 m ² /Element	0,247 m ² /Element
8 piece/pack = 1,98 m ²	7 piece/pack = 1,73 m ²	7 piece/pack = 1,73 m ²
52 pack/pallet = 102,96 m ²	52 pack/pallet = 89,96 m ²	24 pack/pallet = 41,52 m ²
7,21 kg/m ²	9,11 kg/m ²	7,21 kg/m ²
14,28 kg/pack	15,76 kg/pack	12,47 kg/pack
742,56 kg/pallet	819,52 kg/pallet	299,28 kg/pallet

Design/Style	Insulation	ID N°
 NEW Plank 1-Strip 4V OAK EMILIA¹ White Matching skirting ID N° 410 764 		538 689
		538 698 ²
		538 707 ²
 NEW Plank 1-Strip 4V OAK CONTURA¹ Stone Grey Matching skirting ID N° 407 815 		538 696
		538 705
		538 714
 NEW Plank 1-Strip 4V STONEWOOD¹ Creme Matching skirting ID N° 410 771 		538 690
		538 699 ²
		538 708 ²
 NEW Plank 1-Strip 4V OAK EMILIA¹ Velvet Grey Matching skirting ID N° 410 765 		538 695
		538 704 ²
		538 713 ²
 Plank 1-Strip 4V OAK PORTLAND¹ Grey Matching skirting ID N° 409 321 		533 121
		534 146
		533 814
 Plank 1-Strip OAK ANTIQUE GREY¹ Matching skirting ID N° 407 808 		526 671
		527 081 ²
		527 429 ²
 Plank 1-Strip 4V OAK VENETO¹ Crema Matching skirting ID N° 409 320 		535 261
		535 893
		535 894
 Plank 1-Strip 4V CHESTNUT IMPRESSO¹ Matching skirting ID N° 407 818 		526 680
		528 519 ²
		528 012 ²
 Plank 1-Strip SYCAMORE MAPLE¹ Matching skirting ID N° 406 822 		525 659
		525 652 ²
		526 972 ²

Packaging in carton and film. Only delivered in complete packs.

1) Wood reproduction

2) Not within the stock range; product line order (minimum purchasing quantity: 10 sq.m). Delivery time on inquiry.

HDF-Easy Floor Moulding available, see page 186.































Every product printed in red ordered in a minimum quantity of 10 sq.m. is optionally also available with Silent CT or Silent Pro (delivery time on inquiry).

All Laminate Floor products with a Silent Pro or Silent CT product number printed in black in the price list are stock items.



TRITTY 100	TRITTY 100 Silent Pro	TRITTY 100 Silent CT
0,247 m ² /Element	0,247 m ² /Element	0,247 m ² /Element
8 piece/pack = 1,98 m ²	7 piece/pack = 1,73 m ²	7 piece/pack = 1,73 m ²
52 pack/pallet = 102,96 m ²	52 pack/pallet = 89,96 m ²	24 pack/pallet = 41,52 m ²
7,21 kg/m ²	9,11 kg/m ²	7,21 kg/m ²
14,28 kg/pack	15,76 kg/pack	12,47 kg/pack
742,56 kg/pallet	819,52 kg/pallet	299,28 kg/pallet

Design/Style	Insulation	ID N°
 <p>4 a soft</p>		Plank 1-Strip 4V OAK EMILIA puro 538 691
		538 700 ²
 <p>4 a soft</p>		538 709 ²
		3-Strip OAK PREMIUM¹ Creme 526 661
 <p>a</p>		526 765 ²
		528 119 ²
 <p>4 a</p>		Plank 1-Strip 4V OAK PORTLAND¹ Puro 533 122
		533 128
 <p>4 a</p>		533 133
		Plank 1-Strip 4V OAK ITALICA¹ Creme 538 920
 <p>4 a</p>		538 921 ²
		538 922 ²
 <p>4 a soft</p>		Plank 1-Strip 4V OAK EMILIA¹ Honey 538 692
		538 701
 <p>4 a soft</p>		538 710
		Plank 1-Strip OAK ELEGANCE 526 668
 <p>a</p>		528 673 ²
		528 065 ²
 <p>a m</p>		Plank 1-Strip ALPINE OAK¹ Nature 526 676
		528 326
 <p>a m</p>		528 083
		Plank 1-Strip 4V OAK PORTLAND¹ Nature 533 123
<p>4 a</p>		533 129 ²
		533 134 ²
<p>4 a soft</p>		Plank 1-Strip 4V OAK BERGAMO¹ Nature 538 693
		538 702 ²
<p>4 a soft</p>		538 711 ²

Packaging in carton and film. Only delivered in complete packs.

¹ Wood reproduction

² Not within the stock range; product line order (minimum purchasing quantity: 10 sq.m). Delivery time on inquiry.

HDF-Easy Floor Moulding available, see page 186.



Plank 1-Strip/3-Strip

Level of use: 23/32

Abrasion class: AC4

Thickness: 8 mm

Thickness with Silent Pro/Silent CT: 10 mm





















Dimensions: 193 x 1282 mm

Every product printed in red ordered in a minimum quantity of 10 sq.m. is optionally also available with Silent CT or Silent Pro (delivery time on inquiry).

All Laminate Floor products with a Silent Pro or Silent CT product number printed in black in the price list are stock items.



TRITTY 100	TRITTY 100 Silent Pro	TRITTY 100 Silent CT
0,247 m ² /Element	0,247 m ² /Element	0,247 m ² /Element
8 piece/pack = 1,98 m ²	7 piece/pack = 1,73 m ²	7 piece/pack = 1,73 m ²
52 pack/pallet = 102,96 m ²	52 pack/pallet = 89,96 m ²	24 pack/pallet = 41,52 m ²
7,21 kg/m ²	9,11 kg/m ²	7,21 kg/m ²
14,28 kg/pack	15,76 kg/pack	12,47 kg/pack
742,56 kg/pallet	819,52 kg/pallet	299,28 kg/pallet

Design/Style	Insulation	ID N°
 4 a	Plank 1-Strip 4V OAK ITALICA¹ Nature	530 335
	 Silent Pro	530 336 ²
	 Silent CT	530 337 ²
 4 s m	Plank 1-Strip 4V VINTAGE OAK¹	526 678
	 Silent Pro	528 800
	 Silent CT	527 794
 p m	Plank 1-Strip ITALIAN WALNUT¹	526 682
	 Silent Pro	528 262 ²
	 Silent CT	527 427 ²
 p	Plank 1-Strip IROKO¹	529 052
	 Silent Pro	535 896 ²
	 Silent CT	535 897 ²
 4 a	Plank 1-Strip 4V OAK ITALICA¹ Smoked	530 327
	 Silent Pro	530 329
	 Silent CT	530 331
 4 a	NEW Plank 1-Strip 4V OAK CONTURA¹ Smoked	538 697
	 Silent Pro	538 706 ²
	 Silent CT	538 715 ²
 4 a soft	NEW Plank 1-Strip 4V OAK BERGAMO¹ Carbon	538 694
	 Silent Pro	538 703 ²
	 Silent CT	538 712 ²

Packaging in carton and film. Only delivered in complete packs.

1) Wood reproduction

2) Not within the stock range; product line order (minimum purchasing quantity: 10 sq.m). Delivery time on inquiry.

HDF-Easy Floor Moulding available, see page 186.

HARO Laminate Floor TRITTY 100

Loft 4V

The Tough One: slim and narrow

Level of use: 23/32
 Antistatic class: ASF2
 Abrasion class: AC4
 Thickness: 8 mm (with Silent Pro/Silent CT 10 mm)
 Dimensions:
 Loft 4V: 135 x 1282 mm

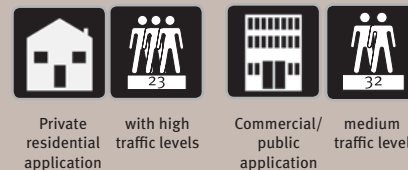

Private residential application

with high traffic levels

Commercial/public application

medium traffic level

Suitable for use with underfloor heating and cooling



HARO TRITTY 100
 Loft 4V
ITALIAN WALNUT
 Pore matt
 (wood reproduction)

optional:
 Silent Pro insulation layer

optional:
 Silent CT (ComforTec) technology

Antistatic class
 ASF2





Level of use: 23/32

Abrasion class: AC4

Thickness: 8 mm

Thickness with Silent Pro/Silent CT: 10 mm

Dimensions: 135 x 1282 mm









Loft with bevel on all four sides

Every product printed in red ordered in a minimum quantity of 10 sq.m. is optionally also available with Silent CT or Silent Pro (delivery time on inquiry).

All Laminate Floor products with a Silent Pro or Silent CT product number printed in black in the price list are stock items.



TRITTY 100 Loft 4V	TRITTY 100 Loft 4V Silent Pro	TRITTY 100 Loft 4V Silent CT
0,173 m ² /Element	0,173 m ² /Element	0,173 m ² /Element
8 piece/pack = 1,38 m ²	6 piece/pack = 1,04 m ²	7 piece/pack = 1,21 m ²
65 pack/pallet = 89,7 m ²	65 pack/pallet = 67,6 m ²	30 pack/pallet = 36,3 m ²
7,21 kg/m ²	9,11 kg/m ²	7,21 kg/m ²
9,95 kg/pack	9,47 kg/pack	8,72 kg/pack
646,75 kg/pallet	615,55 kg/pallet	261,6 kg/pallet

Design/Style	Insulation	ID N°
 <p>Loft 4V OAK EMILIA¹ White</p> <p>Matching skirting ID N° 410 764</p>		538 716
		538 723 ²
		538 740 ²
 <p>Loft 4V SCANDINAVIAN OAK¹</p> <p>Matching skirting ID N° 409 809</p>		538 718
		538 735 ²
		538 742 ²
 <p>Loft 4V OAK VENETO¹ Crema</p> <p>Matching skirting ID N° 409 320</p>		538 719
		538 736 ²
		538 743 ²
 <p>Loft 4V OAK EMILIA¹ Light Grey</p> <p>Matching skirting ID N° 410 761</p>		538 717
		538 734 ²
		538 741 ²
 <p>Loft 4V OAK PORTLAND¹ Puro</p> <p>Matching skirting ID N° 407 800</p>		538 722
		538 739 ²
		538 746 ²
 <p>Loft 4V OAK EMILIA¹ Honey</p> <p>Matching skirting ID N° 408 616</p>		538 720
		538 737 ²
		538 744 ²
 <p>Loft 4V ITALIAN WALNUT¹</p> <p>Matching skirting ID N° 407 820</p>		535 372
		535 883 ²
		535 884 ²
 <p>Loft 4V OAK CONTURA¹ Smoked</p> <p>Matching skirting ID N° 410 760</p>		538 721
		538 738 ²
		538 745 ²

Packaging in carton and film. Only delivered in complete packs.

1) Wood reproduction

2) Not within the stock range; product line order (minimum purchasing quantity: 10 sq.m). Delivery time on inquiry.

HDF-Easy Floor Moulding available, see page 186.

HARO Laminate Floor TRITTY 100

Campus 4V

The Tough One: extra wide

Level of use: 23/32
 Antistatic class: ASF2
 Abrasion class: AC4
 Thickness: 8 mm (with Silent Pro/Silent CT 10 mm)
 Dimensions:
 Campus 4V: 243 x 1282 mm

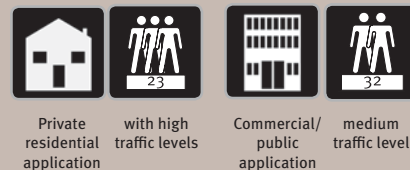

Private residential application

with high traffic levels

Commercial/public application

medium traffic level

Suitable for use with underfloor heating and cooling



optional:
Silent Pro
insulation layer

optional:
Silent CT
(ComforTec)
technology

Antistatic class
ASF2

HARO TRITTY 100
Campus 4V
OAK ITALICA creme
authentic
(wood reproduction)





Level of use: 23/32

Abrasion class: AC4

Thickness: 8 mm

Thickness with Silent Pro/Silent CT: 10 mm

Dimensions: 243 x 1282 mm









Campus with bevel on all four sides

Every product printed in red ordered in a minimum quantity of 10 sq.m. is optionally also available with Silent CT or Silent Pro (delivery time on inquiry).

All Laminate Floor products with a Silent Pro or Silent CT product number printed in black in the price list are stock items.



Tritty 100 Campus 4V	Tritty 100 Campus 4V Silent Pro	Tritty 100 Campus 4V Silent CT
0,312 m ² /Element	0,312 m ² /Element	0,312 m ² /Element
8 piece/pack = 2,49 m ²	7 piece/pack = 2,18 m ²	7 piece/pack = 2,18 m ²
39 pack/pallet = 97,11 m ²	39 pack/pallet = 85,02 m ²	18 pack/pallet = 39,24 m ²
7,21 kg/m ²	9,11 kg/m ²	7,21 kg/m ²
17,95 kg/pack	19,86 kg/pack	15,72 kg/pack
700,05 kg/pallet	774,54 kg/pallet	282,96 kg/pallet

Design/Style	Insulation	ID N°
 <p>NEW Campus 4V OAK EMILIA¹ Velvet White</p> <p>Matching skirting ID N° 410 762</p>		538 751
		538 757 ²
 <p>NEW Campus 4V OAK BERGAMO¹ Silver Grey</p> <p>Matching skirting ID N° 410 754</p>		538 748
		538 760 ²
 <p>NEW Campus 4V OAK LIGURIA¹ Greige</p> <p>Matching skirting ID N° 410 767</p>		538 752
		538 758 ²
 <p>NEW Campus 4V OAK EMILIA¹ Puro</p> <p>Matching skirting ID N° 410 755</p>		538 750
		538 762 ²
 <p>Campus 4V OAK ITALICA¹ Creme</p> <p>Matching skirting ID N° 408 608</p>		532 060
		532 868 ²
 <p>Campus 4V ALPINE OAK¹ Nature</p> <p>Matching skirting ID N° 408 616</p>		532 063
		532 466 ²
 <p>NEW Campus 4V OAK BERGAMO¹ Nature</p> <p>Matching skirting ID N° 408 618</p>		538 747
		538 753 ²
 <p>NEW Campus 4V OAK BERGAMO¹ Antique Smoked</p> <p>Matching skirting ID N° 410 758</p>		538 749
		538 755 ²
 <p>NEW Campus 4V OAK BERGAMO¹ Nature</p> <p>Matching skirting ID N° 410 758</p>		538 749
		538 761 ²

Packaging in carton and film. Only delivered in complete packs.

1) Wood reproduction

2) Not within the stock range; product line order (minimum purchasing quantity: 10 sq.m). Delivery time on inquiry.

HDF-Easy Floor Moulding available, see page 186.

HARO Laminate Floor TRITTY 100

Gran Via 4V

The Tough One: extra long - extra wide

Level of use: 23/32

Antistatic class: ASF2

Abrasion class: AC4

Thickness: 8 mm (with Silent Pro/Silent CT 10 mm)

Dimensions:

Gran Via 4V: 243 x 2200 mm



Private residential application



with high traffic levels



Commercial / public application



medium traffic level

Suitable for use with underfloor heating and cooling



optional:
Silent Pro
insulation layer



optional:
Silent CT
(ComforTec)
technology



Antistatic class
ASF2



HARO TRITTY 100
Gran Via 4V
CHESTNUT BIANCO
textured/matt
(wood reproduction)





Level of use: 23/32

Abrasion class: AC4

Thickness: 8 mm

Thickness with Silent Pro/Silent CT: 10 mm

Dimensions: 243 x 2200 mm











Gran Via with bevel on all four sides

Every product printed in red ordered in a minimum quantity of 10 sq.m. is optionally also available with Silent CT or Silent Pro (delivery time on inquiry).

All Laminate Floor products with a Silent Pro or Silent CT product number printed in black in the price list are stock items.



TRITTY 100 Gran Via 4V	TRITTY 100 Gran Via 4V Silent Pro	TRITTY 100 Gran Via 4V Silent CT
0,535 m ² /Element	0,535 m ² /Element	0,535 m ² /Element
5 piece/pack = 2,68 m ²	4 piece/pack = 2,14 m ²	4 piece/pack = 2,14 m ²
39 pack/pallet = 104,52 m ²	39 pack/pallet = 83,46 m ²	18 pack/pallet = 38,52 m ²
7,21 kg/m ²	9,11 kg/m ²	7,21 kg/m ²
19,32 kg/pack	19,5 kg/pack	15,43 kg/pack
753,48 kg/pallet	760,5 kg/pallet	277,74 kg/pallet

Design/Style	Insulation	ID N°
 <p>Gran Via 4V OAK EMILIA¹ White</p> <p>Matching skirting ID N° 410 764</p>		538 765
		538 774 ²
 <p>Gran Via 4V CHESTNUT BIANCO¹</p> <p>Matching skirting ID N° 409 311</p>		530 303
		530 304 ²
 <p>Gran Via 4V OAK CONTURA¹ Stone Grey</p> <p>Matching skirting ID N° 407 815</p>		531 917
		532 625
 <p>Gran Via 4V HIGHLAND OAK¹</p> <p>Matching skirting ID N° 407 815</p>		532 821
		538 768
 <p>Gran Via 4V OAK EMILIA¹ Velvet Grey</p> <p>Matching skirting ID N° 410 765</p>		538 768
		538 777 ²
 <p>Gran Via 4V ALPINE OAK¹ Grey</p> <p>Matching skirting ID N° 407 814</p>		538 770
		538 786 ²
 <p>Gran Via 4V OAK PORTLAND¹ Grey</p> <p>Matching skirting ID N° 409 321</p>		526 711
		528 732 ²
 <p>Gran Via 4V OAK ANTIQUE GREY¹</p> <p>Matching skirting ID N° 407 808</p>		533 139
		533 911
 <p>Gran Via 4V OAK VENETO¹ Crema</p> <p>Matching skirting ID N° 409 320</p>		526 704
		528 790 ²
 <p>Gran Via 4V OAK VENETO¹ Crema</p> <p>Matching skirting ID N° 409 320</p>		535 269
		535 862
		535 863

Packaging in carton and film. Only delivered in complete packs.

1) Wood reproduction

2) Not within the stock range; product line order (minimum purchasing quantity: 10 sq.m). Delivery time on inquiry.

HDF-Easy Floor Moulding available, see page 186.

Gran Via with bevel on all four sides

Level of use: 23/32

Abrasion class: AC4

Thickness: 8 mm

Thickness with Silent Pro/Silent CT: 10 mm

Dimensions: 243 x 2200 mm



Every product printed in red ordered in a minimum quantity of 10 sq.m. is optionally also available with Silent CT or Silent Pro (delivery time on inquiry).

All Laminate Floor products with a Silent Pro or Silent CT product number printed in black in the price list are stock items.



TRITTY 100 Gran Via 4V	TRITTY 100 Gran Via 4V Silent Pro	TRITTY 100 Gran Via 4V Silent CT
0,535 m ² /Element	0,535 m ² /Element	0,535 m ² /Element
5 piece/pack = 2,68 m ²	4 piece/pack = 2,14 m ²	4 piece/pack = 2,14 m ²
39 pack/pallet = 104,52 m ²	39 pack/pallet = 83,46 m ²	18 pack/pallet = 38,52 m ²
7,21 kg/m ²	9,11 kg/m ²	7,21 kg/m ²
19,32 kg/pack	19,5 kg/pack	15,43 kg/pack
753,48 kg/pallet	760,5 kg/pallet	277,74 kg/pallet

Design/Style	Insulation	ID N°
<p>Gran Via 4V OAK EMILIA¹ Velvet Brown</p> <p>Matching skirting ID N° 410 763</p>		538 771
		538 780 ²
		538 789 ²
<p>Gran Via 4V OAK EMILIA¹ Puro</p> <p>Matching skirting ID N° 410 755</p>		538 769
		538 778 ²
		538 787 ²
<p>Gran Via 4V OAK PORTLAND¹ Puro</p> <p>Matching skirting ID N° 407 800</p>		533 140
		533 145
		533 147
<p>Gran Via 4V OAK ITALICA¹ Creme</p> <p>Matching skirting ID N° 408 608</p>		530 693
		531 293 ²
		531 342 ²
<p>Gran Via 4V OAK EMILIA¹ Honey</p> <p>Matching skirting ID N° 408 616</p>		538 772
		538 781 ²
		538 790 ²
<p>Gran Via 4V ALPINE OAK¹ Nature</p> <p>Matching skirting ID N° 408 616</p>		526 709
		531 290
		527 433
<p>Gran Via 4V OAK PORTLAND¹ Nature</p> <p>Matching skirting ID N° 409 322</p>		533 141
		533 909 ²
		533 148 ²
<p>Gran Via 4V OAK BERGAMO¹ Nature</p> <p>Matching skirting ID N° 408 618</p>		538 766
		538 775 ²
		538 784 ²
<p>Gran Via 4V OAK ITALICA¹ Nature</p> <p>Matching skirting ID N° 408 609</p>		530 338
		531 995 ²
		530 339

Packaging in carton and film. Only delivered in complete packs.

¹ Wood reproduction

² Not within the stock range; product line order (minimum purchasing quantity: 10 sq.m). Delivery time on inquiry.

HDF-Easy Floor Moulding available, see page 186.



Level of use: 23/32

Abrasion class: AC4

Thickness: 8 mm

Thickness with Silent Pro/Silent CT: 10 mm

Dimensions: 243 x 2200 mm









Gran Via with bevel on all four sides

Every product printed in red ordered in a minimum quantity of 10 sq.m. is optionally also available with Silent CT or Silent Pro (delivery time on inquiry).

All Laminate Floor products with a Silent Pro or Silent CT product number printed in black in the price list are stock items.

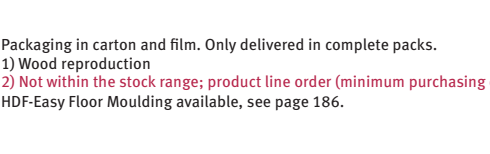

TRITTY 100 Gran Via 4V	TRITTY 100 Gran Via 4V Silent Pro	TRITTY 100 Gran Via 4V Silent CT
0,535 m ² /Element	0,535 m ² /Element	0,535 m ² /Element
5 piece/pack = 2,68 m ²	4 piece/pack = 2,14 m ²	4 piece/pack = 2,14 m ²
39 pack/pallet = 104,52 m ²	39 pack/pallet = 83,46 m ²	18 pack/pallet = 38,52 m ²
7,21 kg/m ²	9,11 kg/m ²	7,21 kg/m ²
19,32 kg/pack	19,5 kg/pack	15,43 kg/pack
753,48 kg/pallet	760,5 kg/pallet	277,74 kg/pallet

Design/Style	Insulation	ID N°
 Matching skirting ID N° 407 816	Silent Pro	526 712
	Silent CT	531 289
 Matching skirting ID N° 408 620	Silent Pro	526 934
	Silent CT	532 453 ²
 Matching skirting ID N° 409 183	Silent Pro	528 324 ²
	Silent CT	533 142
 Matching skirting ID N° 408 607	Silent Pro	533 925 ²
	Silent CT	534 017 ²
 Matching skirting ID N° 407 820	Silent Pro	530 333
	Silent CT	531 811
 Matching skirting ID N° 410 760	Silent Pro	530 334
	Silent CT	531 811
 Matching skirting ID N° 407 808	Silent Pro	526 714
	Silent CT	531 292 ²
 Matching skirting ID N° 409 327	Silent Pro	538 773
	Silent CT	538 782 ²
 Matching skirting ID N° 407 808	Silent Pro	538 773
	Silent CT	538 791 ²
 Matching skirting ID N° 409 327	Silent Pro	538 767
	Silent CT	538 776 ²
 Matching skirting ID N° 409 327	Silent Pro	538 785 ²
	Silent CT	538 785 ²
 Matching skirting ID N° 409 327	Silent Pro	533 144
	Silent CT	535 190 ²
 Matching skirting ID N° 409 327	Silent Pro	535 190 ²
	Silent CT	534 217 ²

Packaging in carton and film. Only delivered in complete packs.

1) Wood reproduction

2) Not within the stock range; product line order (minimum purchasing quantity: 10 sq.m). Delivery time on inquiry.

HDF-Easy Floor Moulding available, see page 186.

HARO Laminate Floor TRITTY 200 Aqua

The premium laminate floor with moisture protection



Level of use: 23/33
 Antistatic class: ASF2
 Abrasion class: AC6
 Thickness: 8 mm (mit Silent Pro/Silent CT 10 mm)
 Dimensions: 193 x 1282 mm

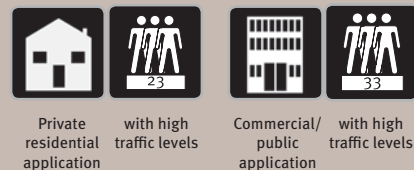

Suitable for use with underfloor heating and cooling

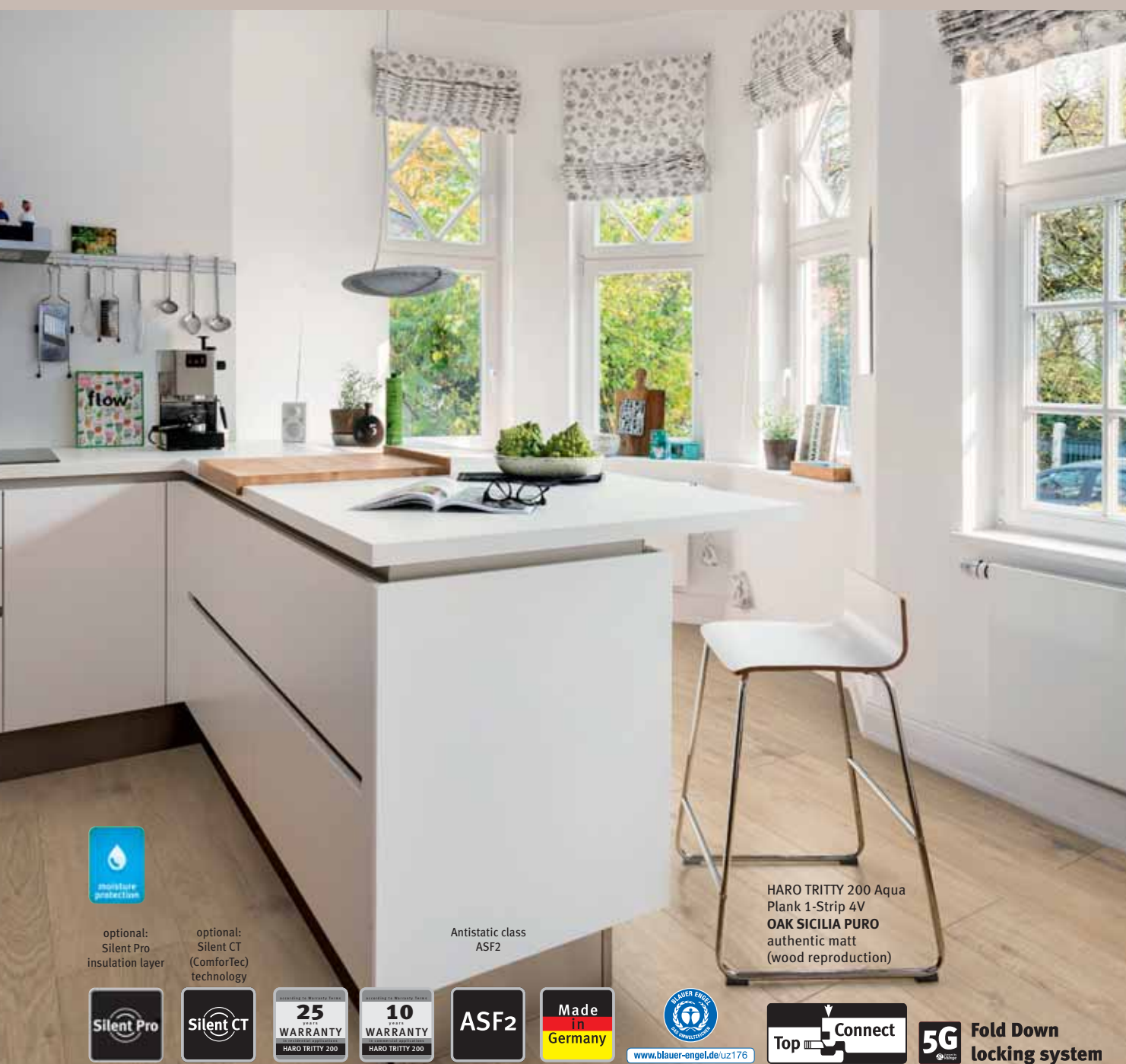

HARO TRITTY 200 Aqua
 Plank 1-Strip 4V
OAK SICILIA PURO
 authentic matt
 (wood reproduction)



optional:
 Silent Pro
 insulation layer

optional:
 Silent CT
 (ComforTec)
 technology

Antistatic class
 ASF2





Level of use: 23/33

Abrasion class: AC6

Thickness: 8 mm

Thickness with Silent Pro/Silent CT: 10 mm

Dimensions: 193 x 1282 mm

Plank 1-Strip

Every product ordered in a minimum quantity of 10 sq.m. is optionally also available with Silent CT or Silent Pro (delivery time on inquiry).

All Laminate Floor products with a Silent Pro or Silent CT product number printed in black in the price list are stock items.



TRITTY 200 Aqua	TRITTY 200 Aqua Silent Pro	TRITTY 200 Aqua Silent CT
0,247 m ² /Element	0,247 m ² /Element	0,247 m ² /Element
8 piece/pack = 1,98 m ²	7 piece/pack = 1,73 m ²	7 piece/pack = 1,73 m ²
52 pack/pallet = 102,96 m ²	44 pack/pallet = 76,12 m ²	24 pack/pallet = 41,52 m ²
7,36 kg/m ²	9,26 kg/m ²	7,36 kg/m ²
14,57 kg/pack	16,02 kg/pack	12,73 kg/pack
757,64 kg/pallet	704,88 kg/pallet	305,52 kg/pallet

Design/Style	Insulation	ID N°
 4 a m		Plank 1-Strip 4V OAK SICILIA¹ White 537 368
		537 380 ²
		537 392 ²
NEW 4 a soft		Plank 1-Strip 4V OAK EMILIA¹ Velvet White 539 147
		539 151 ²
		539 155 ²
 4 a m		Plank 1-Strip 4V OAK VENETO¹ Sand 537 369
		537 381 ²
		537 393 ²
NEW 4 a		Plank 1-Strip 4V OAK PORTLAND¹ Puro 539 146
		539 150 ²
		539 154 ²
 4 a m		Plank 1-Strip 4V OAK SICILIA¹ Puro 537 370
		537 382 ²
		537 394 ²
 4 a m		Plank 1-Strip 4V OAK VENETO¹ Mocca 537 373
		537 385 ²
		537 397 ²
 4 a m		Plank 1-Strip 4V OAK SICILIA¹ Nature 537 371
		537 383 ²
		537 395 ²
 4 a m		Plank 1-Strip 4V OAK VENETO¹ Honey 537 372
		537 384 ²
		537 396 ²

Packaging in carton and film. Only delivered in complete packs.

1) Wood reproduction

2) Not within the stock range; product line order (minimum purchasing quantity: 10 sq.m). Delivery time on inquiry.

HDF-Easy Floor Moulding available, see page 186.

HARO Laminate Floor TRITTY 200 Aqua Gran Via 4V

The premium laminate floor with moisture protection: extra long - extra wide



Level of use: 23/33
 Antistatic class: ASF2
 Abrasion class: AC6
 Thickness: 8 mm (mit Silent Pro/Silent CT 10 mm)
 Dimensions: 243 x 2200 mm

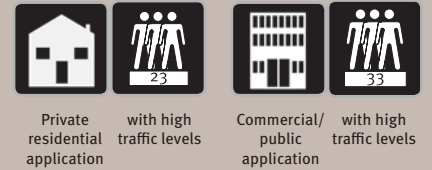

Suitable for use with underfloor heating and cooling

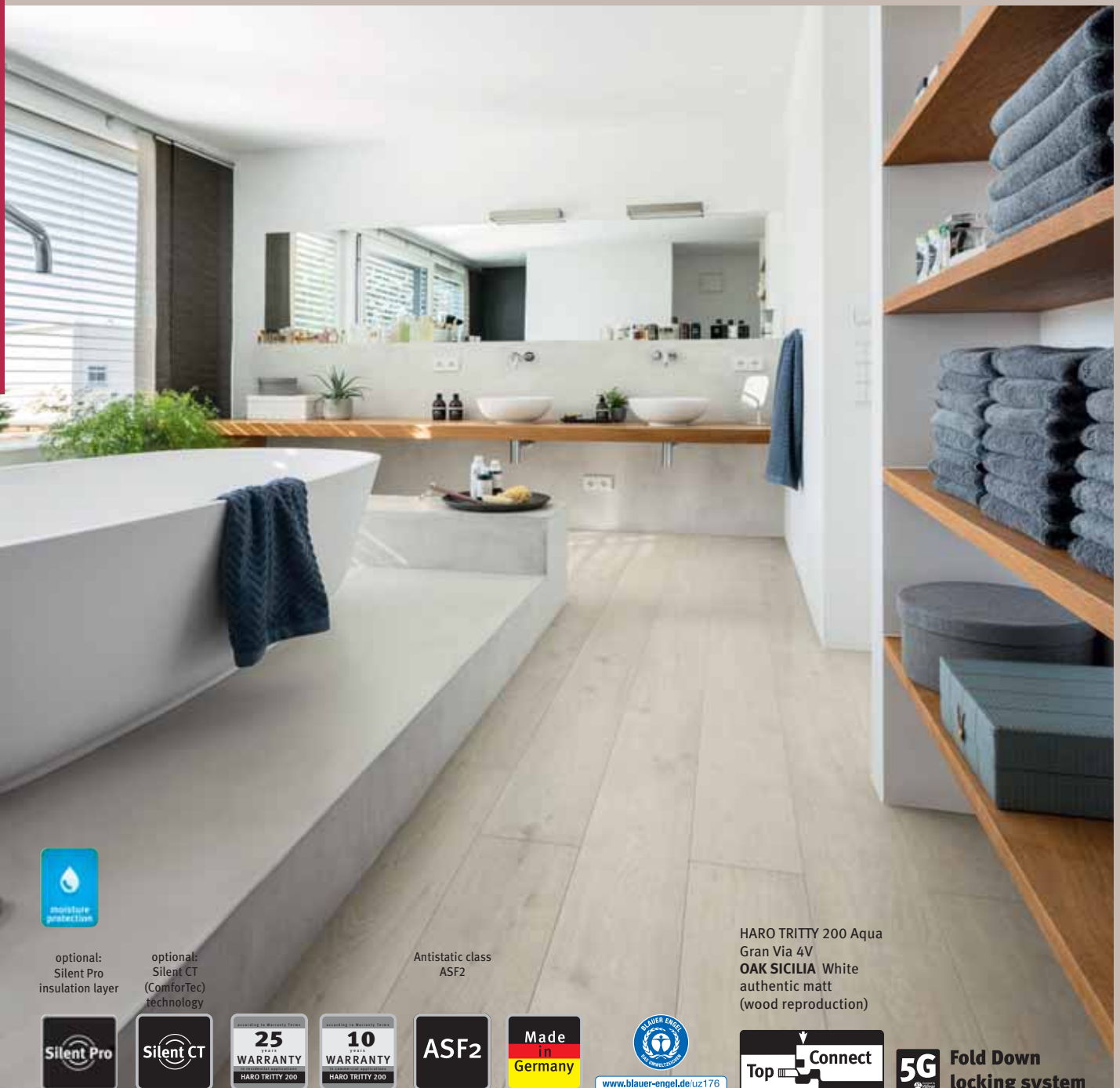

optional:
Silent Pro
insulation layer

optional:
Silent CT
(ComForTec)
technology

Antistatic class
ASF2



HARO TRITTY 200 Aqua
Gran Via 4V
OAK SICILIA White
authentic matt
(wood reproduction)





Level of use: 23/33

Abrasion class: AC6

Thickness: 8 mm

Thickness with Silent Pro/Silent CT: 10 mm

Dimensions: 243 x 2200 mm

Gran Via with bevel on all four sides

Every product ordered in a minimum quantity of 10 sq.m. is optionally also available with Silent CT or Silent Pro (delivery time on inquiry).

All Laminate Floor products with a Silent Pro or Silent CT product number printed in black in the price list are stock items.



Tritty 200 Aqua Gran Via 4V	Tritty 200 Aqua Gran Via 4V Silent Pro	Tritty 200 Aqua Gran Via 4V Silent CT
0,535 m ² /Element	0,535 m ² /Element	0,535 m ² /Element
5 piece/pack = 2,68 m ²	4 piece/pack = 2,14 m ²	4 piece/pack = 2,14 m ²
36 pack/pallet = 96,48 m ²	36 pack/pallet = 77,04 m ²	18 pack/pallet = 38,52 m ²
7,36 kg/m ²	9,26 kg/m ²	7,36 kg/m ²
19,72 kg/pack	19,82 kg/pack	15,75 kg/pack
709,92 kg/pallet	713,52 kg/pallet	283,5 kg/pallet

Design/Style	Insulation	ID N°
 Matching skirting ID N° 410 398		537 374
		537 386 ²
		537 398 ²
NEW Matching skirting ID N° 410 822		539 149
		539 153 ²
		539 157 ²
 Matching skirting ID N° 410 399		537 375
		537 387 ²
		537 399 ²
NEW Matching skirting ID N° 410 823		539 148
		539 152 ²
		539 156 ²
 Matching skirting ID N° 410 400		537 376
		537 388 ²
		537 400 ²
 Matching skirting ID N° 410 403		537 379
		537 391 ²
		537 403 ²
 Matching skirting ID N° 410 401		537 377
		537 389 ²
		537 401 ²
 Matching skirting ID N° 410 402		537 378
		537 390 ²
		537 402 ²

Packaging in carton and film. Only delivered in complete packs.

1) Wood reproduction

2) Not within the stock range; product line order (minimum purchasing quantity: 10 sq.m). Delivery time on inquiry.

HDF-Easy Floor Moulding available, see page 186.

HARO Cork Floor

Bringing nature into your home.

Cork floors from HARO are not only the perfect complement to a classic natural style. They offer many versatile design options, as you can see from our Arteo cork floor range with digitally printed wood reproductions.



Fold Down locking system

HARO CORKETT
DESIGN ARTEO XL 4V
SHABBY OAK GREY
brushed
(wood reproduction)

Technical construction



3-layer construction with HDF E1 coreboard

1. permaDur high finish
2. Cork top layer, approx. 3 mm or approx. 2.5 mm with Sirio
Overall thickness approx. 11 mm; Sirio: approx. 10.5 mm
for Arto XL 4V:
Cork top layer, approx. 2 mm
Total thickness: approx. 10 mm
3. HDF E1 coreboard (approx. 6,8 mm)
4. Cork footfall sound insulation (approx. 1.2 mm)

- Only real cork can create such a natural and comfortable ambience:
- Brand quality – Made in Germany
- Natural product from the bark of the cork oak
- Renewable natural resource
- Extensive range to meet every taste
- Warm to the touch, elastic and kind to joints and spine, sound proofing effect
- Easy to install with Top Connect, even on underfloor heating
- Durable and easy to maintain
- 5 years warranty



Cork classic

Simply pleasant, with classic cork look
Board dimensions: 298 x 907 mm

Kork Arto XL 4V

Exceptional wood styles combined with the advantages of the pure natural product cork
Always trendy and stylish, with genuine bevelled edges on four sides
Board dimensions: 195 x 1235 mm



Natural look
Cork – a piece of nature



Resilient and kind to
joints and spine



Dimensionally stable due
to multilayer construction



Suitable for
underfloor heating



Warm to the touch







Easy to maintain



Healthy indoor climate

Dimensions: 11 x 298 x 907 mm (Sirio 10,5 mm)
 Top layer thickness: approx. 3 mm (Sirio approx. 2,5 mm)
 Packaging: 7 piece/pack = 1,89 m²
 48 pack/pallet = 90,72 m²
 8,22 kg/m²; 15,54 kg/pack;
 745,92 kg/pallet
 3-layer construction with HDF E1 coreboard
 Level of use: 23/31



Design/Style		Finish	ID N°
	DESIGN SIRIO Creme	P_m	533 391
	Matching skirting ID N° 406 991		
	DESIGN SIRIO Nature	P_m	527 374
	Matching skirting ID N° 410 798		
	DESIGN ARCOS Antique White	P_m	527 387
	Matching skirting ID N° 406 990		
	DESIGN LAGOS Nature	P_m	527 377
	Matching skirting ID N° 410 798		
	DESIGN RONDA Nature	P_m	527 381
	Matching skirting ID N° 410 798		





HARO CORKETT
 DESIGN SIRIO
 creme



Dimensions: 10 x 195 x 1235 mm
 Top layer thickness: approx. 2 mm
 Packaging: 8 piece/pack = 1,93 m²
 44 pack/pallet = 84,92 m²
 8,39 kg/m²; 16,19 kg/pack;
 712,36 kg/pallet
 3-layer construction with HDF E1 coreboard
 Level of use: 23/33



Design Arteo XL 4V

Design/Style	Finish	ID N°
 <p>Design Arteo XL 4V OAK PORTLAND WHITE¹ brushed</p> <p>Matching skirting ID N° 410 415</p>	<u>Pm</u>	537 262
 <p>Design Arteo XL 4V OAK PORTLAND INVISIBLE¹ brushed</p> <p>Matching skirting ID N° 410 414</p>	<u>Pm</u>	537 263
 <p>Design Arteo XL 4V OAK PORTLAND NATURELL¹ brushed</p> <p>Matching skirting ID N° 410 412</p>	<u>Pm</u>	537 265
 <p>Design Arteo XL 4V OAK PORTLAND DARK GREY¹ brushed</p> <p>Matching skirting ID N° 410 413</p>	<u>Pm</u>	537 264
 <p>Design Arteo XL 4V SHABBY OAK WHITE¹ brushed</p> <p>Matching skirting ID N° 410 418</p>	<u>Pm</u>	537 259
 <p>Design Arteo XL 4V SHABBY OAK INVISIBLE¹ brushed</p> <p>Matching skirting ID N° 410 417</p>	<u>Pm</u>	537 260
 <p>Design Arteo XL 4V SHABBY OAK GREY¹ brushed</p> <p>Matching skirting ID N° 410 416</p>	<u>Pm</u>	537 261
 <p>Design Arteo XL 4V OAK DUNA¹ brushed</p> <p>Matching skirting ID N° 409 058</p>	<u>Pm</u>	537 258
 <p>Design Arteo XL 4V OAK ITALICA NATURE¹ brushed</p> <p>Matching skirting ID N° 409 057</p>	<u>Pm</u>	537 257
 <p>Design Arteo XL 4V OAK ITALICA SMOKED¹ brushed</p> <p>Matching skirting ID N° 409 056</p>	<u>Pm</u>	537 256

DISANO by HARO

The Design Floor for Healthy Living

100 % free from PVC and plasticisers

Our DISANO Design Floors impress with the outstanding properties of a modern comfort floor. In addition, they are healthy living at its best in every aspect and a benefit for every room with their spacious formats. All DISANO design floors are suitable for high-traffic residential and commercial areas.

- For a healthy living environment: 100 % free from PVC and plasticisers
- Awarded the Blue Angel label and the Eco Label
- Free of heavy metals and phthalates
- Soft, warm to the touch and quiet
- Temperature-resistant and dimensionally stable
- Authentic wood and stone styles with bevelled edges or micro bevel on 4 sides
- Resistant to fading under UV light - no colour changes
- Durable



DISANO Classic Aqua
Plank 1-Strip 4V
SAND OAK
brushed
(wood reproduction)

Private residential application



with high traffic levels



Commercial/public application



with high traffic levels



up to



DISANO by HARO

Five Series

DISANO Saphir

4,5 x 235 x 1282 mm



DISANO Classic Aqua

9,3 x 235 x 2035 mm



DISANO SmartAqua

6,5 x 235 x 1282 mm



DISANO SmartAqua Design Piazza

6,5 x 313 x 631 mm



NEW

DISANO Life

8 x 235 x 1800 mm



DISANO Project

2 x 248 x 1300 mm



DISANO Project Design Piazza

2 x 310 x 650 mm

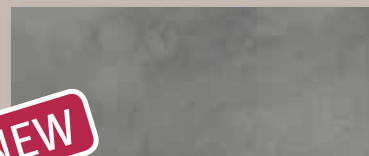

NEW

SURFACES



Brushed



authentic



rustic textured



Bevelled edge on the long and short sides



4-sided micro bevel

DISANO Saphir

The hard-wearing design floor for all requirements. Water-proof.

- Waterproof; fully water resistant, even with standing water
- Suitable for glue-down installation in the bathroom (with HARO Flexible Glue ID no.: 410 536)
- Authentic wood styles with micro bevel on 4 sides
- Extremely hard-wearing and durable thanks to the waterproof coreboard
- Renovation-friendly installation height of only 4.5 mm
- Easy to install with the Top Connect installation system
- Highly suitable for use with underfloor heating and cooling
- For floating installation, use insulation underlay Silent Grip ID no. 409 272
- Fire protection class (with glue-down installation) C_{fl}-s2

4,5 x 235 x 1282 mm



1. The SilentSense surface with its authentic wood look is elastic, soft and comfortably warm, protects the floor, provides it with durability and is easy to clean. The decorative layer gives the product an authentic wood look.
2. Due to the durable, waterproof full-plastic coreboard DISANO Saphir is exceptionally hard-wearing and also approved for glue-down installation in damp rooms (WO-1 in accordance with DIN 18534), such as domestic bathrooms or kitchens. In addition, the special material composition of the coreboard ensures high elasticity and thus a pleasantly soft feeling.

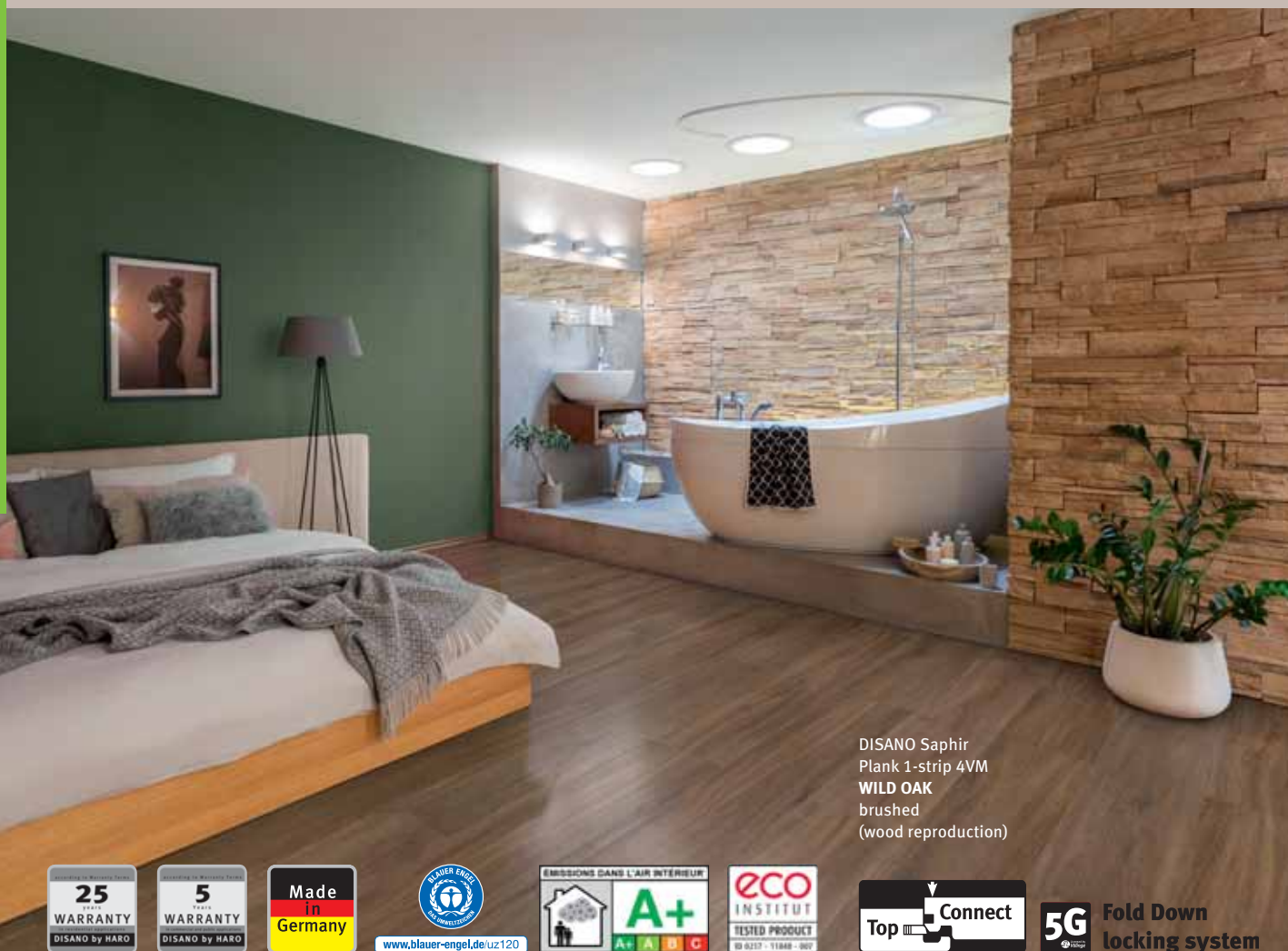

DISANO Saphir
Plank 1-strip 4VM
WILD OAK
brushed
(wood reproduction)



www.blauer-engel.de/uz120













Level of use: 23/33
 Thickness: 4,5 mm
 Dimensions: 235 x 1282 mm

DESIGN FLOOR

DISANO BY HARO

DISANO Saphir

Packaging:
 0,301 m²/Element
 10 piece/pack = 3,01 m²
 45 pack/pallet = 135,45 m²
 5,28 kg/m²; 15,9 kg/pack
 715,5 kg/pallet

Design/Style	ID N°
	Plank 1-strip 4VM CRYSTAL OAK¹ 537 240 Matching skirting ID N° 410 088
	Plank 1-strip 4VM COUNTRY OAK GREY¹ 537 241 Matching skirting ID N° 410 091
	Plank 1-strip 4VM HOLM OAK CREME¹ 537 236 Matching skirting ID N° 409 410
	Plank 1-strip 4VM SAND OAK¹ 537 237 Matching skirting ID N° 409 409
	Plank 1-strip 4VM FIELD OAK¹ 537 242 Matching skirting ID N° 410 093
	Plank 1-strip 4VM WILD OAK¹ 537 238 Matching skirting ID N° 409 412
	Plank 1-strip 4VM TOBACCO OAK¹ 537 243 Matching skirting ID N° 410 094
	Plank 1-strip 4VM FRENCH SMOKED OAK¹ 537 239 Matching skirting ID N° 409 406

DESIGN FLOOR

DISANO Classic Aqua

The comfortable design floor for upscale living. Also for damp areas.

- Resistant to moisture, also suitable for damp rooms (W0-1 in accordance with DIN 18534), such as domestic bathrooms or kitchens, with glue-down installation (with HARO Flexible Glue ID no. 410 536)
- Withstands standing water for only 4 hours.
- Authentic wood styles in XL long-board format with bevelled edge on 4 sides
- Resistant to temperature and UV light, dimensionally stable
- Easy to install with the Top Connect installation system
- Highly suitable for use with underfloor heating and cooling
- Fire protection class (with glue-down installation) C_{fl}-s1

9,3 x 235 x 2035 mm



1. The SilentSense surface with its authentic wood look is elastic, soft and comfortably warm, protects the floor, provides it with durability and is easy to clean.
2. The ElastoTec layer provides additional elasticity and walking comfort. It protects the floor from dents and penetrating moisture while ensuring improved stability.
3. The AquaReject core board based on natural materials is particularly resistant against swelling. This is why DISANO is also approved for glue-down installation in damp rooms (W0-1 according to DIN 18534), such as domestic bathrooms or kitchens.
4. High-density cork insulation layer for reduction of room and footfall sound, as well as optimised walking comfort.



DISANO Classic Aqua
Plank 1-Strip 4V
TOBACCO OAK
brushed
(wood reproduction)



www.blauer-engel.de/uz176



Fold Down locking system









Level of use: 23/33
 Thickness: 9,3 mm
 Dimensions: 235 x 2035 mm

DESIGN FLOOR

DISANO BY HARO











DISANO Classic Aqua

Packaging:
 0,478 m²/Element/Element
 5 pcs./pallet = 2,39 m²
 39 pack/pallet = 93,21 m²
 8,41 kg/m²; 20,1 kg/pack
 783,9 kg/pallet

Design/Style	ID N°
 Matching skirting ID N° 410 097	Plank 1-Strip 4V OAK WHITE¹ 536 238
 Matching skirting ID N° 409 415	Plank 1-Strip 4V OAK GLACIER¹ 536 065
 Matching skirting ID N° 410 088	Plank 1-Strip XL 4V CRYSTAL OAK¹ 536 242
 Matching skirting ID N° 409 407	Plank 1-Strip XL 4V PINE NORDICA¹ 536 066
 Matching skirting ID N° 410 089	Plank 1-Strip XL 4V LIGHT OAK¹ 536 244
 Matching skirting ID N° 409 413	Plank 1-Strip XL 4V OAK RIVA¹ 536 067
 Matching skirting ID N° 410 091	Plank 1-Strip XL 4V COUNTRY OAK GREY¹ 536 251
 Matching skirting ID N° 410 090	Plank 1-Strip XL 4V VINTAGE OAK GREIGE¹ 536 249
 Matching skirting ID N° 409 410	Plank 1-Strip XL 4V HOLM OAK CREME^{1 2} 535 699
 Matching skirting ID N° 410 092	Plank 1-Strip XL 4V COUNTRY OAK NATURE^{1 2} 536 250

**Packaging:**

0,478 m²/Element,
5 pcs./pallet = 2,39 m²
39 pack/pallet = 93,21 m²
8,41 kg/m²; 20,1 kg/pack
783,9 kg/pallet

Design/Style	ID N°	
	Plank 1-Strip XL 4V SAND OAK¹ Matching skirting ID N° 409 409	535 703
	Plank 1-Strip XL 4V OAK NATURE¹ Matching skirting ID N° 410 096	536 239
	Plank 1-Strip XL 4V FIELD OAK¹ Matching skirting ID N° 410 093	536 247
	Plank 1-Strip XL 4V MOUNTAIN OAK¹ Matching skirting ID N° 409 401	535 702
	Plank 1-Strip XL 4V WILD OAK^{1 2} Matching skirting ID N° 409 412	535 700
	Plank 1-Strip XL 4V TOBACCO OAK¹ Matching skirting ID N° 410 094	536 248
	Plank 1-Strip XL 4V WALNUT¹ Matching skirting ID N° 410 095	536 240
	Plank 1-Strip XL 4V FRENCH SMOKED OAK^{1 2} Matching skirting ID N° 409 406	535 701
	Plank 1-Strip 4V OAK PROVENCE CREME¹ Matching skirting ID N° 410 789	538 970
	Plank 1-Strip 4V OAK PROVENCE NATURE¹ Matching skirting ID N° 410 790	538 971



Level of use: 23/33
 Thickness: 9,3 mm
 Dimensions: 235 x 2035 mm

DESIGN FLOOR

DISANO BY HARO

DISANO Classic Aqua

Packaging:
 0,478 m²/Element/Element
 5 pcs./pallet = 2,39 m²
 39 pack/pallet = 93,21 m²
 8,41 kg/m²; 20,1 kg/pack
 783,9 kg/pallet

Design/Style

ID N°

NEW



Plank 1-Strip 4V
OAK PROVENCE SMOKED¹

538 972



Matching skirting
 ID N° 410 791



DISANO Classic Aqua
 Plank 1-Strip 4V
OAK GLACIER
 brushed
 (wood reproduction)

DESIGN FLOOR

DISANO SmartAqua

The smart design floor for young living. Also for damp areas.

- Resistant to moisture, also suitable for damp rooms (W0-1 in accordance with DIN 18534), such as domestic bathrooms or kitchens, with glue-down installation (with HARO Flexible Glue ID no. 410 536)
- Withstands standing water for only 4 hours.
- Authentic wood styles with micro bevel on 4 sides
- Particularly suitable for renovations thanks to its low profile
- Durable and dimensionally stable
- Resistant to temperature and fading under UV light
- Easy to install with the Top Connect installation system
- Highly suitable for use with underfloor heating and cooling
- Fire protection class (with glue-down installation) Bfl-s1

6,5 x 235 x 1282 mm

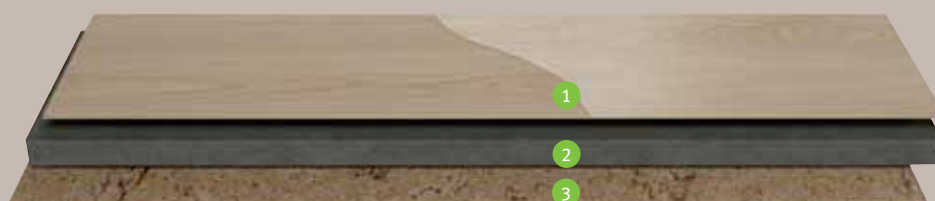

1. The SilentSense surface with its authentic wood look is elastic, soft and comfortably warm, protects the floor, provides it with durability and is easy to clean.
2. The AquaReject core board based on natural materials is particularly resistant against swelling. This is why DISANO is also approved for glue-down installation in damp rooms (W0-1 according to DIN 18534), such as domestic bathrooms or kitchens.
3. High-density cork insulation layer for reduction of room and footfall sound, as well as optimised walking comfort.



DISANO SmartAqua
Plank 1-Strip 4VM
ANTIQUE OAK SMOKED
rustic textured(
wood reproduction)



www.blauer-engel.de/uz176

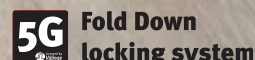



Level of use: 23/33
 Thickness: 6,5 mm
 Dimensions: 235 x 1282 mm

DESIGN FLOOR

DISANO BY HARO

DISANO SmartAqua

Packaging:
 0,301 m²/Element
 10 piece/pack = 3,01 m²
 39 pack/pallet = 117,39 m²
 5,61 kg/m²; 16,9 kg/pack
 659,1 kg/pallet

Design/Style	ID N°
 Matching skirting ID N° 410 357	537 123
 Matching skirting ID N° 410 359	537 115
 Matching skirting ID N° 410 358	537 114
 Matching skirting ID N° 410 360	537 117
 Matching skirting ID N° 410 361	537 118
 Matching skirting ID N° 410 425	537 119
 Matching skirting ID N° 410 362	537 169
 Matching skirting ID N° 410 363	537 120
 Matching skirting ID N° 410 364	537 170
 Matching skirting ID N° 410 365	537 121

DESIGN FLOOR

DISANO SmartAqua Design Piazza

NEW

The smart design floor for young living. Also for damp areas.

- Resistant to moisture, also suitable for damp rooms (W0-1 in accordance with DIN 18534), such as domestic bathrooms or kitchens, with glue-down installation (with HARO Flexible Glue ID no. 410 536)
- Withstands standing water for only 4 hours.
- Authentic stone styles with bevelled edges on 4 sides
- Particularly suitable for renovations thanks to its low profile
- Durable and dimensionally stable
- Resistant to temperature and fading under UV light
- Easy to install with the Top Connect installation system
- Highly suitable for use with underfloor heating and cooling
- Fire protection class (with glue-down installation) Bfl-s1



6,5 x 313 x 631 mm



1. The SilentSense surface with its authentic stone look is elastic, soft and comfortably warm, protects the floor, provides it with durability and is easy to clean.
2. The AquaReject core board based on natural materials is particularly resistant against swelling. This is why DISANO is also approved for glue-down installation in damp rooms (W0-1 according to DIN 18534), such as domestic bathrooms or kitchens.
3. High-density cork insulation layer for reduction of room and footfall sound, as well as optimised walking comfort.



www.blauer-engel.de/uz176









Level of use: 23/33
 Thickness: 6,5 mm
 Dimensions: 313 x 631 mm

DESIGN FLOOR

DISANO BY HARO

DISANO SmartAqua

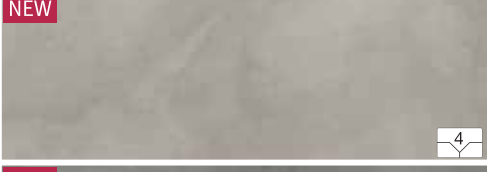
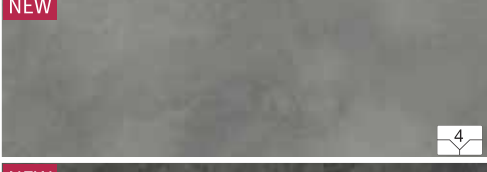
Packaging:
 0,198 m²,
 10 piece/pack = 1,98 m²
 45 pack/pallet = 89,1 m²
 5,61 kg/m²; 11,11 kg/pack
 499,95 kg/pallet

Design/Style	ID N°
<p>NEW</p>  <p>Matching skirting ID N° 410 792</p>	<p>Design Piazza 4V MARBLE WHITE¹ Stone texture</p> <p>538 973</p>
<p>NEW</p>  <p>Matching skirting ID N° 410 793</p>	<p>Design Piazza 4V ARTDESIGN CREMA¹ Stone texture</p> <p>538 974</p>
<p>NEW</p>  <p>Matching skirting ID N° 410 794</p>	<p>Design Piazza 4V SAND STONE¹ Stone texture</p> <p>538 975</p>
<p>NEW</p>  <p>Matching skirting ID N° 410 795</p>	<p>Design Piazza 4V CONCRETE LIGHT¹ Stone texture</p> <p>538 976</p>
<p>NEW</p>  <p>Matching skirting ID N° 410 796</p>	<p>Design Piazza 4V CONCRETE GREY¹ Stone texture</p> <p>538 977</p>
<p>NEW</p>  <p>Matching skirting ID N° 410 797</p>	<p>Design Piazza 4V SLATE ANTHRAZIT¹ Stone texture</p> <p>538 978</p>

DISANO Life

The smart design floor for young living.

- Durable and dimensionally stable
- Resistant to temperature and fading under UV light
- Authentic wood styles in XL long-board format with bevelled edge on 4 sides
- Easy to install with the Top Connect installation system
- Suitable for use with underfloor heating and cooling
- Fire protection class (with glue-down installation) Dfl-s1

8 x 235 x 1800 mm



1. The SilentSense surface with its authentic wood look is elastic, soft and comfortably warm, protects the floor, provides it with durability and is easy to clean.
2. The HydroResist coreboard based on natural materials is particularly resistant against moisture compared to common coreboards out of wood materials.
3. High-density cork insulation layer for reduction of room and footfall sound, as well as optimised walking comfort.



DISANO Life
Plank 1-Strip 4V
OAK COLUMBIA NATURE
brushed
(wood reproduction)

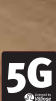

Fold Down locking system



Level of use: 23/33
 Thickness: 8 mm
 Dimensions: 235 x 1800 mm

DESIGN FLOOR

DISANO BY HARO

DISANO Life

Packaging:
 0,423 m²/Element,
 8 piece/pack = 3,38 m²/Element
 30 pack/pallet = 101,4 m²
 7 kg/m²; 23,66 kg/pack
 709,8 kg/pallet

Design/Style	ID N°
 Matching skirting ID N° 409 623	534 230
 Matching skirting ID N° 409 666	534 399
 Matching skirting ID N° 410 084	536 254
 Matching skirting ID N° 409 621	534 234
 Matching skirting ID N° 409 619	534 233
 Matching skirting ID N° 410 085	536 253
 Matching skirting ID N° 409 620	534 235
 Matching skirting ID N° 410 086	536 255
 Matching skirting ID N° 410 087	536 252

DESIGN FLOOR

DISANO Project

The design floor for professional installation. Water-proof.

- Waterproof; fully water resistant, even with standing water. Suitable for installation in the bathroom.
- Glue-down installation with HARO Dispersion Adhesive ID no. 410 566
- Authentic wood styles with micro bevel on 4 sides
- Especially suitable for renovations and remodelling thanks to low profile
- High stability through the special layer construction
- Highly suitable for use with underfloor heating and cooling
- Fire protection classification Bfl-s1

2 x 248 x 1300 mm

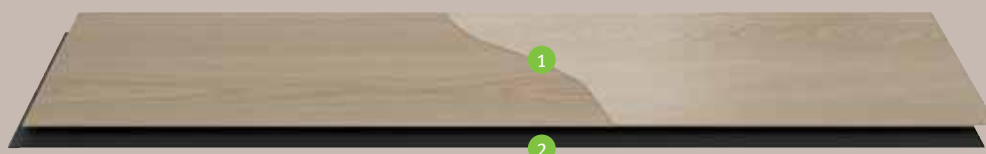

1. The SilentSense surface with its authentic wood look is elastic, soft and comfortably warm, protects the floor, provides it with durability and is easy to clean.
2. The ElastoTec layer protects the floor from dents and penetrating moisture while ensuring improved stability.



www.blauer-engel.de/uz120



DISANO Project
Plank 1-Strip 4VM
CRYSTAL OAK
brushed
(wood reproduction)











Level of use: 23/33
 Thickness: 2 mm
 Dimensions: 248 x 1300 mm

DESIGN FLOOR

DISANO BY HARO

DISANO Project

Packaging:
 0,322 m²/Element
 11 boards/pack = 3,54 m²
 63 pack/pallet = 223,02 m²
 3,33 kg/m²; 11,8 kg/pack
 743,4 kg/pallet

Design/Style	ID N°	
	Plank 1-strip 4VM CRYSTAL OAK¹ Matching skirting ID N° 410 088	537 296
	Plank 1-strip 4VM COUNTRY OAK GREY¹ Matching skirting ID N° 410 091	537 297
	Plank 1-strip 4VM HOLM OAK CREME¹ Matching skirting ID N° 409 410	537 298
	Plank 1-strip 4VM SAND OAK¹ Matching skirting ID N° 409 409	537 299
	Plank 1-strip 4VM FIELD OAK¹ Matching skirting ID N° 410 093	537 300
	Plank 1-strip 4VM WILD OAK¹ Matching skirting ID N° 409 412	537 301
	Plank 1-strip 4VM TOBACCO OAK¹ Matching skirting ID N° 410 094	537 302
	Plank 1-strip 4VM FRENCH SMOKED OAK¹ Matching skirting ID N° 409 406	537 303

DESIGN FLOOR

NEW

DISANO Project Design Piazza

The design floor for professional installation. Water-proof.

- Waterproof; fully water resistant, even with standing water. Suitable for installation in the bathroom.
- Glue-down installation with HARO Dispersion Adhesive ID no. 410 566
- Authentic stone styles with micro bevel on 4 sides
- Especially suitable for renovations and remodelling thanks to low profile
- High stability through the special layer construction
- Highly suitable for use with underfloor heating and cooling
- Fire protection classification Bfl-s1

2 x 310 x 650 mm



1. The SilentSense surface with its authentic stone look is elastic, soft and comfortably warm, protects the floor, provides it with durability and is easy to clean.
2. The ElastoTec layer protects the floor from dents and penetrating moisture while ensuring improved stability.



www.blauer-engel.de/uz120







Level of use: 23/33
 Thickness: 2 mm
 Dimensions: 310 x 650 mm

DESIGN FLOOR

DISANO BY HARO

DISANO Project Design Piazza

Packaging:
 0,201 m²/Element,
 11 piece/pack = 2,22 m²
 90 pack/pallet = 199,8 m²
 3,33 kg/m²; 7,39 kg/pack
 665,1 kg/pallet

Design/Style	ID N°
<p>NEW</p>  <p>Matching skirting ID N° 410 792</p>	<p>Design Piazza 4VM MARBLE WHITE¹ Stone texture</p> <p>539 135</p>
<p>NEW</p>  <p>Matching skirting ID N° 410 795</p>	<p>Design Piazza 4VM CONCRETE LIGHT¹ Stone texture</p> <p>539 137</p>
<p>NEW</p>  <p>Matching skirting ID N° 410 797</p>	<p>Design Piazza 4VM SLATE ANTHRAZIT¹ Stone texture</p> <p>539 136</p>

CELENIO BY HARO

The Unique Wood Floor

Exclusive quality for a completely new style of living with wood

- Natural
- Warm to the touch
- Highly break-resistant
- Easy to install with Top Connect
- Effortless to maintain
- Formats: 350 x 703 mm



CELENIO ATHOS POLAR GREY

optional

for residential applications

Antistatic class ASF2



Fold Down locking system

www.blauer-engel.de/uz176

CELENIO combines the advantages of wood with the look of stone and slate. The result is more than impressive: Strikingly beautiful on the outside, tough and durable on the inside – for previously unimaginable design possibilities.

- Brand quality – Made in Germany
- Innovative product made of Harolith wood-based material
- Modern surface textures and colours
- Warm to the touch and comfortable
- Excellent break resistance
- Easy to install, even on underfloor heating
- Resistant and easy to maintain



Natural
Wonderfully warm, natural and vibrant.



Warm to the touch
Wood in a different form creates a comfortable and cosy environment.



Highly break-resistant
CELENIO provides excellent resilience.



Easy to install
With Top Connect, probably the world's easiest installation system.



CELENIO with Silent Pro
Pleasant acoustic by minimising both footfall and room sound.



Effortless to maintain
Being a wood floor, CELENIO is very easy to maintain with clean & green natural.



Exclusive wall design
Three exciting designs provide an impressive background to extravagant interiors.











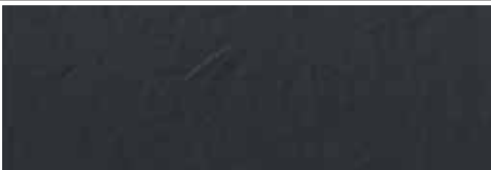



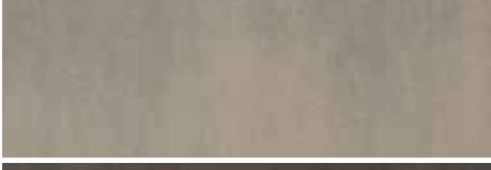

FORMATS

	Top Connect	Top Connect with Silent Pro
ATRIUM	6,5 x 350 x 703 mm	8,5 x 350 x 703 mm
ATHOS	6,5 x 350 x 703 mm	8,5 x 350 x 703 mm
ARDESIA	6,5 x 350 x 703 mm	8,5 x 350 x 703 mm

Thickness: 6,5 mm
 Thickness with Silent Pro: 8,5 mm
 Dimensions: 350 x 703 mm

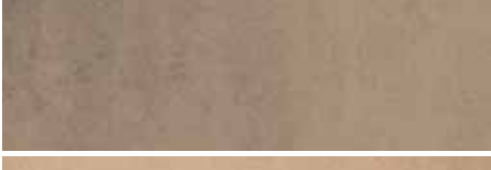

CELENIO Top Connect	CELENIO with Silent Pro
10 piece/pack = 2,46 m ²	8 piece/pack = 1,97 m ²
39 pack/pallet = 95,94 m ²	39 pack/pallet = 76,83 m ²
7,15 kg/m ²	9,05 kg/m ²
17,59 kg/pack	17,83 kg/pack
686,01 kg/pallet	695,37 kg/pallet

Design/Style	Insulation	ID N°
 ARDESIA ONYX Slate design single-colour Matching skirting ID N° 406 977		537 177
		537 185 ¹
 ATRIUM ANTHRAZIT Slate design single-colour Matching skirting ID N° 406 964		537 178
		537 187 ¹
 ATHOS ACHAT Natural stone design two-tone Matching skirting ID N° 406 968		537 179
		537 188 ¹
 ATHOS CONCRETE GREY Natural stone design two-tone Matching skirting ID N° 408 224		537 180
		537 189 ¹
 ATHOS POLAR GREY Natural stone design three-coloured Matching skirting ID N° 406 973		537 181
		537 190 ¹
 ATHOS FERRO Natural stone design three-coloured Matching skirting ID N° 406 972		537 182
		537 191 ¹
 ATHOS SAVANNA Natural stone design two-tone Matching skirting ID N° 408 222		537 183
		537 192 ¹
 ATHOS SAHARA Natural Stone Design multi-colour Matching skirting ID N° 406 971		537 184
		537 193 ¹

Packaging in carton and film. Only delivered in complete cartons.

Slight colour variances might occur due to the use of natural wood fibres in this product.

¹ Not within the stock range; product line order (minimum purchasing quantity: 10 sq.m). Delivery time on inquiry!



CELENIO ARDESIA ONYX

CELENIO
ATRIUM ANTHRAZIT

Natural beauty as a room concept

With its interior product range, HARO is expanding its wood and design expertise from floors to interior design.

Naturalness is what counts when it comes to the design of modern rooms that radiate a sense of comfort. With HARO Interior we offer attractive possibilities for using the unique charisma of wood not only for floors, but also for wall design, the panelling of stairs and even for your living room table.

HARO TABLE – PRECIOUS WOOD TABLES Page 135

HARO WALL – WALL PANELS Page 136

HARO STAIRS – STAIR TRIM Page 140



Precious wood tables

The tables are produced with original HARO Parquet and give your living spaces an individual touch. Whether rustic or classic - we offer the perfect solution. Further dimensions and wood types can be found at the table configurator at www.haro.com.



Precious wood table Oak Alabama brushed

- Made of original HARO Parquet
- Rustic with vibrant wood structure, knots and cracks with black filling
- Table surface finish: naturaLin plus natural oil

Length: 200 cm
Width: 85 cm
Height: 75 cm
Visible thickness of the tabletop 5 cm

Table frame model:

- Black steel, base width 8 cm
- Stainless steel, base width 8 cm

Table frame model	ID N°	PU		
Black steel	535 228	1 pc.		
Stainless Steel	535 394	1 pc.		

Precious wood table Oak Markant brushed

- Made of original HARO Parquet
- Classic and timeless, with natural knots
- Table surface finish: naturaLin plus natural oil

Length: 200 cm
Width: 85 cm
Height: 75 cm
Visible thickness of the tabletop 5 cm

Table frame model:

- Black steel, base width 8 cm
- Stainless steel, base width 8 cm

Table frame model	ID N°	PU		
Black steel	535 226	1 pc.		
Stainless Steel	535 392	1 pc.		

Precious wood table Smoked Oak Sauvage brushed

- Made of original HARO Parquet
- Trendy rustic look with vibrant wood texture and a greater amount of knots
- Table surface finish: naturaLin plus natural oil

Length: 200 cm
Width: 85 cm
Height: 75 cm
Visible thickness of the tabletop 5 cm

Table frame model:

- Black steel, base width 8 cm
- Stainless steel, base width 8 cm

Table frame model	ID N°	PU		
Black steel	535 227	1 pc.		
Stainless Steel	535 393	1 pc.		

HARO Interior

HARO WALL design wood for your wall - Fast, easy and safely to install

- One of the easiest and fastest systems for wall panels
- Particularly natural design thanks to carefully selected precious wood types
- A particularly natural look due to its matt oil surface finishes with various textures
- No frame necessary due to its low installation height
- No nails, screws or drilling necessary

Remove protection foil.

The Comfortec adhesive strips beneath are for immediate adhesion

Apply mounting adhesive.

Press on - finished.



HARO WALL - DESIGN
NEVADA

Design Wood on the wall

HARO Wall - Design Nevada

Available in the thicknesses 3.7mm, 4.7mm and 7.3mm, mixed per pack
Dimensions: 62 x 496 mm

Packaging:

60 pcs./pack = 1.86 sq.m. (3 mixed thicknesses)
50 pack/pallet = 93.0 m²
3.06 kg/sq.m.; 5.69 kg/pack; 284.5 kg /pallet

	Wood species	ID N°		
NEW	OAK RIVER WHITE heavy brushed oiled ¹	538 859		
	OAK RIVER heavy brushed oiled ¹	535 624		
NEW	FUMED OAK RIVER INVISIBLE heavy brushed oiled ¹	538 860		
NEW	OAK RIVER GREY heavy brushed oiled ¹	538 861		

¹ HARO Wall may only be installed with the HARO mounting adhesive.

HARO Wall - Design Patagonia

11.2 mm thick
Dimensions: 120 x 1000 mm

Packaging:

24 pcs/pack = 2.88 m²
18 packs/pallet = 51.84 m²
5.34 kg/m²; 15.38 kg/pack; 276.84 kg /pallet

	Wood species	ID N°		
	OAK RIVER brushed oiled ¹	535 625		
	OAK RIVER HEAVY brushed oiled ¹	535 626		
	OAK BARRIQUE RIVER heavy brushed oiled ¹	535 627		
	SMOKED OAK RIVER heavy brushed oiled ¹	535 628		
	AMERICAN WALNUT RIVER brushed oiled ¹	535 629		
	THERMO OAK LAKE brushed oiled ¹	535 630		
	AFRICAN OAK LAKE HEAVY brushed oiled ¹	535 631		

¹ HARO Wall may only be installed with the HARO mounting adhesive.



HARO mounting adhesive

- Very good initial adhesion
- Permanently elastic, odourless curing
- Solvent free, silicone free, isocyanate free, free from plasticising ingredients
- Versatile, e.g. for HARO Interior Wall and Stairs, skirtings and mouldings

Content: 310 ml
Coverage: approx. 1 m²

ID N°	PU	Min. quant. f. discount		
409 847	1 pc.	12 pc.		

HARO Interior

HARO WALL – Flooring on the wall

Click system for wall panels

With tailor-made system solutions specially designed for HARO Flooring, HARO gives you the possibility to decorate your walls with your favourite floor. Whether it's parquet (13.5 mm), laminate floor (7 / 8 mm) or CELENIO (6,5 mm) – we offer the ideal solution.

You will find the relevant installation instructions and installation video at www.haro.com/en/service (product section „Accessories“) or directly using the following QR Code:

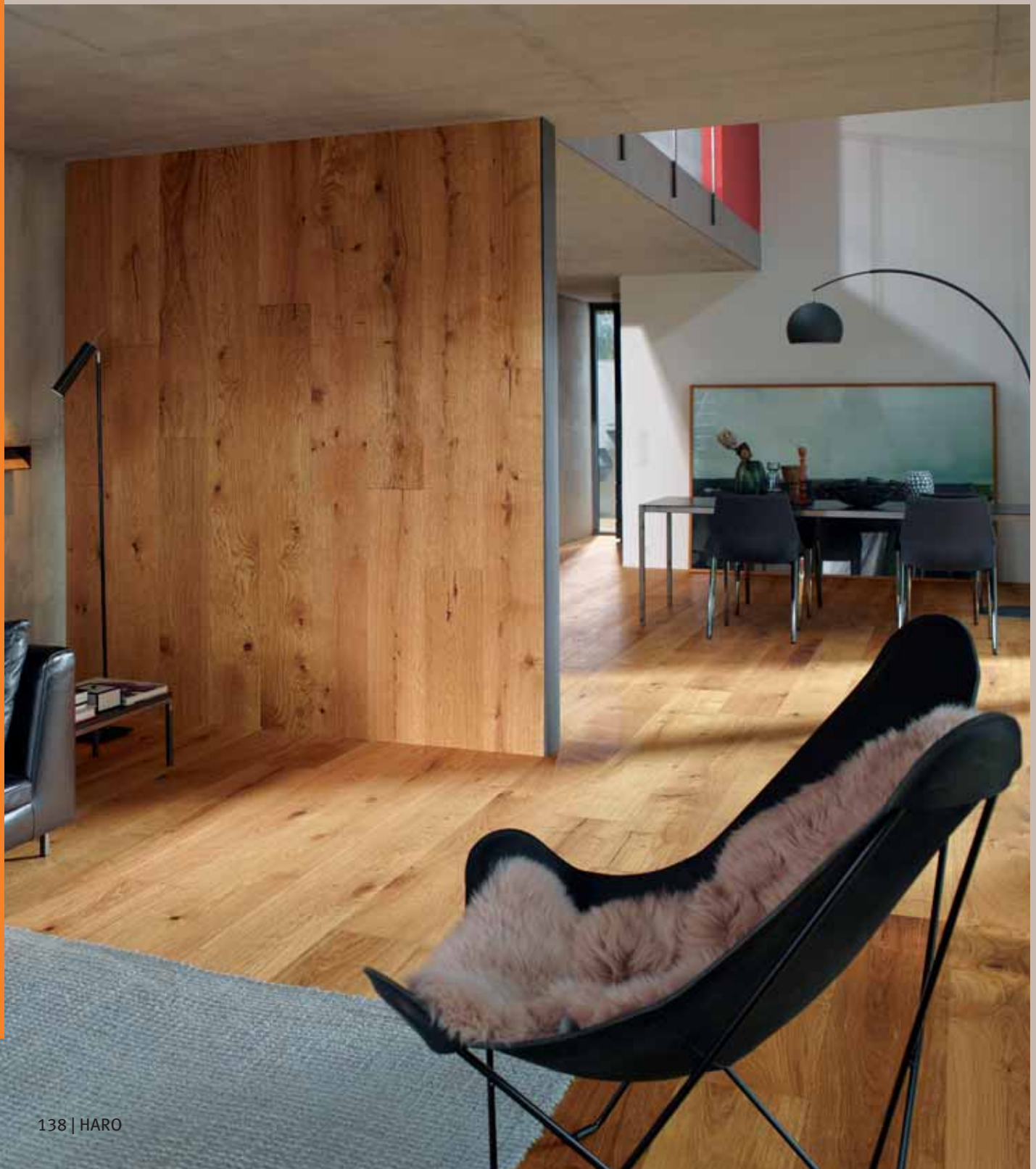

Click system for wall panels



Mounting rail

Substructure for wall mounting of HARO flooring.
Suitable for HARO Parquet 4000 Series (13.5 mm), HARO Laminate Floor TRITTY 90 / TRITTY 100 (7 mm, 8 mm) and Celenio (6,5 mm).

For wall mounting of 1 m² of flooring you will need:

- Parquet/laminate: approx. 2.2 m
- CELENIO: approx. 3.2 m

Length: 250 cm
Height x width: 8x26 mm

ID N°	PU	Min. quant. f. discount		
409 374	1 pc.	10 pc.		



Start and end clips

for wall mounting the first row and the last row of the HARO floor.

Suitable for HARO Parquet 4000 Series (13.5 mm), HARO Laminate Floor TRITTY 90 / TRITTY 100 (7 mm, 8 mm) and Celenio (6,5 mm).

Screws included

Content/pack: 20 pcs.

ID N°	PU	Min. quant. f. discount		
409 377	1 pack	-		



Mounting clips

for fastening the respective HARO flooring to the mounting rail.

Suitable for HARO Parquet 4000 Series (13.5 mm), HARO Laminate Floor TRITTY 90 / TRITTY 100 (7 mm, 8 mm) and Celenio (6,5 mm)

About 15 mounting clips are needed for 1 m² of wall covering.

Content/pack: 100 pcs.

	ID N°	PU	Min. quant. f. discount		
for Parquet 13.5 mm	409 371	1 pack	-		
for Laminate 8 mm	409 372	1 pack	-		
for Celenio 6.5 mm / Laminate Floor 7 mm	410 397	1 pack	-		

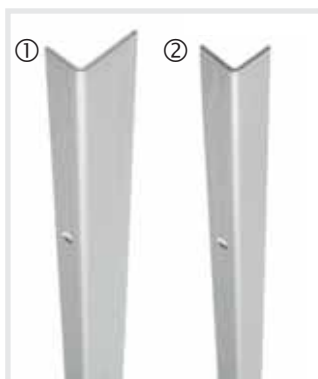

Aluminium cover strip for parquet, laminate floor and CELENIO

for an elegant transition from the floor to the wall.

Countersunk centre holes, hole spacing 50 cm

Screws included.

Length: 250 cm

	ID N°	PU	Min. quant. f. discount		
Cover strip in stainless steel look for parquet (15 x 20 mm) ①	409 375	1 pc.	-		
Cover strip in stainless steel look for laminate floor/Celenio (15 x 15 mm) ②	409 376	1 pc.	-		



Cover strip for parquet (made of original parquet board)

for the perfect ending of floor coverings at the wall

Delivery time approx. 2 weeks

Length: 218 cm

	ID N°	PU	Min. quant. f. discount		
Cover strip for parquet, made of original parquet board (60 x 25 mm)	533 195	1 pc.	-		

Stair nosings PARQUET PLANK 1-STRIP 13,5 mm

Stair noses made of HARO PARQUET
for glue-down installation

Product line order,
Delivery time approx. 2 weeks

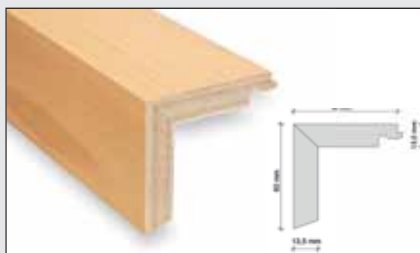

**Stair nosing with connection
on one side**

Tread: 60 mm
Riser: 60 mm



**Stair nosing with connection
on both sides**

Tread: 120 mm (* 113 mm)
Riser: 60 mm

Length: 218 cm
PU: 1 piece

**for Plank 1-Strip Parquet 13.5 mm
with permaDur finish**

	ID N°		ID N°	
African Oak	526 834		538 139 *	
American Walnut Markant	532 235		538 140	
Beech Steamed Universal	538 517		538 525	
Canadian Maple Markant	532 234		538 146	
Oak Exklusiv	530 495		538 147	
Oak Invisible Markant textured	538 513		538 521	
Oak Invisible Sauvage textured	538 514		538 522	
Oak Light White Markant textured	532 228		538 149	
Oak Light White Sauvage textured	532 229		538 150	
Oak Markant	530 496		538 151	
Oak Markant brushed	532 230		538 152	
Oak Puro White Markant textured	538 408		538 519	
Oak Puro White Sauvage textured	538 409		538 520	
Oak Sand Grey Markant textured	538 515		538 523	
Oak Sand Grey Sauvage textured	538 516		538 524	
Oak Sauvage brushed	526 847		538 155	
Ash Light White Universal textured	538 518		538 526	
Merbau Universal	526 857		538 157	

**for Parquet Plank 1-Strip 13.5 mm with
naturaDur surface**

	ID N°		ID N°	
American walnut Markant	535 026		538 214	
Smoked Oak Markant brushed	535 052		538 215 *	
Smoked Oak Sauvage brushed	535 053		538 216 *	
Beech Steamed Universal	535 395		538 217	
Oak invisible Markant brushed	535 046		538 220	
Oak invisible Sauvage brushed	535 047		538 221	
Oak Markant brushed	535 048		538 218	
Oak Puro White Markant brushed	538 564		538 567	
Oak Puro White Sauvage brushed	538 565		538 568	
Oak Sand Grey Markant brushed	535 050		538 222	
Oak Sand Grey Sauvage brushed	535 051		538 223	
Oak Sand White Markant brushed	535 044		538 224	
Oak Sand White Sauvage brushed	535 045		538 225	
Oak Sauvage brushed	535 049		538 219	
Ash Sand White Universal brushed	535 396		538 226	

Length: 218 cm
PU: 1 piece

**Stair nosing with connection
on one side**

Tread: 60 mm
Riser: 60 mm

**Stair nosing with connection
on both sides**

Tread: 120 mm (* 113 mm)
Riser: 60 mm

NEW

for Plank 1-Strip Parquet 13.5 mm with naturaLin plus natural oil finish	ID N°		ID N°		
African Oak brushed	526 868		538 158 *		
American Walnut Markant	530 512		538 160		
American Walnut Universal	538 535		538 553		
Smoked Oak Markant brushed	530 507		538 161 *		
Smoked Oak Sauvage brushed	530 508		538 162 *		
Smoked Oak Sauvage retro brushed	535 043		538 163 *		
Beech Steamed Universal textured	538 531		538 549		
Oak Alabama brushed	530 514		538 165		
Oak Atelier Sauvage retro brushed	532 221		538 166		
Oak Creme White Markant brushed	530 522		538 168		
Oak Creme White Sauvage brushed	530 509		538 169		
Oak Exklusiv brushed	532 217		538 170		
Oak Invisible Markant textured	535 039		538 182		
Oak Invisible Sauvage textured	535 040		538 183		
Oak Crystal White Markant brushed	538 536		538 554		
Oak Crystal White Sauvage brushed	538 537		538 555		
Oak Markant brushed	530 526		538 173		
Oak Shell Grey Markant brushed	538 540		538 558		
Oak Shell Grey Sauvage brushed	538 541		538 559		
Oak Puro White Alabama brushed	530 515		538 194		
Oak Puro White Exklusiv brushed	532 218		538 196		
Oak Puro White Markant textured	526 861		538 197		
Oak Puro White Sauvage textured	532 215		538 199		
Oak Puro White Sauvage retro brushed	535 027		538 198		
Oak Sand Grey Markant textured	538 529		538 547		
Oak Sand Grey Sauvage textured	538 530		538 548		
Oak Sand White Markant brushed	538 527		538 545		
Oak Sand White Sauvage brushed	538 528		538 546		
Oak Sauvage retro brushed	532 219		538 201		
Oak Sauvage brushed	526 862		538 202		
Oak Reed Brown Markant brushed	538 542		538 560		
Oak Reed Brown Sauvage brushed	538 543		538 561		
Oak Tobacco Grey Sauvage retro brushed	532 220		538 203		
Ash Fancy brushed	530 529		538 204 *		
Larch Puro White Universal brushed	538 532		538 550		
Larch Tobacco Grey Universal retro brushed	538 533		538 551		
Larch Universal brushed	538 534		538 552		
Fumed Oak Invisible Sauvage brushed	538 539		538 557		
Fumed Oak Puro White Sauvage brushed	538 544		538 562		
Fumed Oak Sauvage brushed	538 538		538 556		
Thermo Oak Forte brushed	532 222		538 208 *		
Thermo Ash Mezzo brushed	532 223		538 209 *		

Stair nosings PARQUET LONGSTRIP 13,5 mm

Stair noses made of HARO PARQUET for glue-down installation.

Product line order
Delivery time approx. 2 weeks

Length: 218 cm
PU: 1 piece

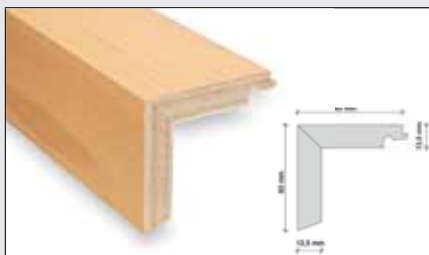

Stair nosing with connection on one side

Tread: 60 mm
Riser: 60 mm



Stair nosing with connection on both sides

Tread: 120 mm
Riser: 60 mm

for Longstrip Parquet 13.5 mm with permaDur finish	ID N°		ID N°	
African Oak Favorit	532 185		538 228	
African Oak Trend	526 889		538 227	
American Cherry Favorit	532 197		538 230	
American Cherry Trend	526 899		538 229	
American Walnut Favorit	532 198		538 231	
American Walnut Trend	526 839		538 232	
Smoked Oak Favorit	533 162		538 234	
Smoked Oak Trend	526 887		538 233	
Amber Robinia Favorit	535 055		538 235	
Beech Steamed Favorit	532 189		538 236	
Beech Steamed Trend	526 836		538 237	
Canadian Maple Favorit	532 194		538 239	
Canadian Maple Trend	526 838		538 238	
Oak Exquisit	532 171		538 240	
Oak Favorit brushed	538 569		538 573	
Oak Invisible Favorit textured	538 570		538 574	
Oak Light White Favorit brushed	532 168		538 241	
Oak Puro White Favorit textured	538 571		538 575	
Oak Sand Grey Favorit textured	538 572		538 576	
Oak Terra	532 173		538 248	
Oak Trend ¹	526 837 ¹		538 249	
Oak Trend brushed	532 172		538 250	
Ash Favorit	532 192		538 252	
Ash Light White Favorit brushed	532 190		538 254	
Ash Trend	526 894		538 255	
Merbau Favorit	526 902		538 256	

¹ In stock

for Longstrip Parquet 13.5 mm with naturaDur finish	ID N°		ID N°	
American Walnut Favorit	535 070		538 288	
Smoked Oak Trend brushed	535 400		538 289	
Beech Steamed Trend	535 068		538 290	
Oak Invisible Favorit textured	538 586		538 591	
Oak Puro White Favorit textured	538 585		538 590	
Oak Sand Grey Favorit textured	538 584		538 589	
Oak Sand White Favorit textured	538 583		538 588	
Oak Trend brushed	535 398		538 294	
Ash Sand White Favorit textured	538 587		538 592	

Length: 218 cm PU: 1 piece	Stair nosing with connection on one side			Stair nosing with connection on both sides		
	Tread: 60 mm Riser: 60 mm			Tread: 120 mm Riser: 60 mm		
for Longstrip Parquet 13.5 mm with naturaLin plus natural oil finish	ID N°			ID N°		
African Oak Trend brushed	530 488			538 257		
American Walnut Trend	526 914			538 258		
Smoked Oak Favorit brushed	535 064			538 260		
Beech Steamed Favorit brushed	526 908			538 261		
Oak Exquisit brushed	532 165			538 263		
Oak Invisible Favorit textured	538 579			538 582		
Oak Puro White Exquisit brushed	532 166			538 275		
Oak Puro White Favorit textured	530 478			538 276		
Oak Puro White Terra retro brushed 3D	533 372			538 279		
Oak Puro White Trend brushed	533 366			538 274		
Oak Sand Grey Favorit textured	538 578			538 581		
Oak Sand White Favorit textured	538 577			538 580		
Oak Tobacco Grey Terra retro brushed 3D	533 159			538 281		
Oak Terra retro brushed 3D	533 363			538 284		
Oak Terra brushed	530 477			538 282		
Oak Trend brushed	530 476			538 286		
Wenge Favorit	526 907			538 287		

Stair nosings STRIP PARQUET Maxim

Stair noses made of HARO PARQUET for glue-down installation.

Product line order
Delivery time approx. 2 weeks

Length: 218 cm
PU: 1 piece



Stair nosing with connection on one side

Tread: 60 mm
Riser: 60 mm



Stair nosing with connection on both sides

Tread: 120 mm (* 113 mm)
Riser: 60 mm

For Maxim strip parquet 10 mm with naturaDur finish	ID N°			ID N°		
	Oak Markant brushed	536 330			538 296	
Oak Sauvage brushed	536 331			538 297		
Oak Invisible Markant textured	536 332			538 298		
Oak Invisible Sauvage textured	536 333			538 299		
Oak Sand Grey Markant textured	536 334			538 300		
Oak Sand Grey Sauvage textured	536 335			538 301		
Oak Sand White Markant brushed	536 336			538 302		
Oak Sand White Sauvage brushed	536 337			538 303		

For Maxim strip parquet 10 mm with naturaLin plus natural oil finish	ID N°			ID N°		
	Smoked Oak Markant brushed	536 327			538 304 *	
Smoked Oak Sauvage brushed	536 329			538 305 *		
Oak Markant brushed	532 238			538 306		
Oak Sauvage brushed	532 240			538 307		
Oak Puro White Markant brushed	532 237			538 308		
Oak Puro White Sauvage brushed	532 239			538 309		

Stair nosings STRIP PARQUET PRESTIGE

Stair noses made of HARO PARQUET
for glue-down installation.

Product line order
Delivery time approx. 2 weeks

Length: 98 cm
PU: 1 piece

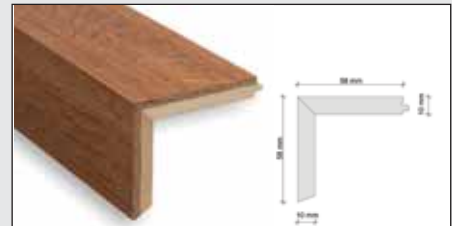

Stair nosing with connection
on one side

Tread: 58 mm
Riser: 58 mm

for Strip Parquet Prestige 10 mm with naturaDur surface finish	ID N°		
Oak Invisible Markant textured	536 321		
Oak Markant brushed	536 322		
Oak Sauvage brushed	536 323		

For Prestige strip parquet 10 mm with naturaLin plus natural oil finish	ID N°		
African Oak Markant	526 927		
Smoked Oak Markant	526 926		
Oak Markant	526 925		
Oak Puro White Markant textured	530 535		
Oak Sauvage	536 318		

Stair nosings STRIP PARQUET SCALA

Stair noses made of HARO PARQUET
for glue-down installation.

Product line order
Delivery time approx. 2 weeks

Length: 173 cm
PU: 1 piece



Stair nosing with connection
on one side

Tread: 60 mm
Riser: 60 mm

for Scala strip parquet 10 mm with naturaDur surface finish	ID N°		
Oak Markant brushed	536 325		
Oak Sauvage brushed	536 326		

For Scala strip parquet 10 mm with naturaLin plus natural oil finish	ID N°		
Smoked Oak Markant brushed	530 555		
Oak Markant brushed	530 552		
Oak Sauvage brushed	530 553		
Oak Puro White Markant textured	530 554		
Oak Invisible Sauvage textured	536 324		

Stair nosings PARQUET



Stair nosing for Parquet with edge-protection

Stair noses made of HARO PARQUET for glue-down installation incl. edge protection aluminium silver anodised

Delivery time approx. 2 weeks
Product line order

Length:

Parquet 13.5 mm: 218 cm (Surface layer dimensions 60x60 mm)
Parquet 10 mm: Strip Prestige 98 cm (Surface layer dimensions 58x58 mm)
Strip Scala 173 cm (Surface layer dimensions 60x60 mm)
Strip Maxim 218 cm (Surface layer dimensions 60x60 mm)

Wood species	ID N°	PU	Min. quant. f. discount		
As chosen	535 020	1 pc.	–		



Stair nosing, angled

Stair nosing Parquet Custom-made

Other wood species, sizes and connection systems are available for our stair nosings on request.

Product number for Parquet ID no. 527 908
Delivery time approx. 3 weeks

Stair nosings LAMINATE FLOOR



Stair nosings for Laminate Floors with edge-protection for TRITTY 100 (8 mm), TRITTY 200 Aqua (8 mm)

Stair noses made of HARO LAMINATE for glue-down installation (using single-component synthetic-resin mounting adhesive) incl. edge protection profile made of silver anodised aluminium.

For the top step please use the Euro-Step stair nosing type 320 (ID No. 404 946). This makes it possible to continue with a floating floor installation.

Product line order
Delivery time approx. 2 weeks

Style	ID N°	PU	Min. quant. f. discount		
As chosen	533 190	1 pc.	–		



Stair nosing incl. connections

Stair nosing Laminate Floor Custom-made

On request, other styles, formats and connections are available for the entire range of stair nosings.

Product number for Laminate ID no. 533 190
Delivery time approx. 3 weeks

Stair nosings DISANO CLASSIC AQUA

Stair noses made of DISANO Classic Aqua Design Floor for glue-down installation

Product line order,
Delivery time approx. 2 weeks



Stair nosing with connection on one side

Tread: 60 mm
Riser: 60 mm

Length: 200 cm
PU: 1 piece

for DISANO Classic Aqua design floor 9.3 mm	ID N°		
Mountain Oak	538 842		
Country Oak Grey	538 602		
Country Oak Nature	538 605		
Oak Glacier	538 597		
Oak Nature	538 840		
Oak Provence Creme	538 593		
Oak Provence Smoked	538 595		
Oak Provence Nature	538 594		
Oak Riva	538 601		
Vintage Oak Greige	538 603		
Oak White	538 596		
Field Oak	538 841		
French Smoked Oak	538 846		
Crystal Oak	538 598		
Light Oak	538 600		
Walnut	538 845		
Pine Nordica	538 599		
Sand Oak	538 606		
Holm Oak Creme	538 604		
Tobacco Oak	538 844		
Wild Oak	538 843		



NEW

Stair nosings DISANO Classic Aqua with edge protection

Stair noses made of DISANO Design Floor for glue-down installation incl. edge protection aluminium silver anodised

Delivery time approx. 2 weeks

Length: 200 cm

Style	ID N°	PU	Min. quant. f. discount		
As chosen	539 134	1 pc.	-		



Stair nosing incl. connections

Stair nosing DISANO Custom-made

On request, other formats and connections are available for the entire range of stair nosings.

Product number for Disano Design Floor ID no. 538 334
Delivery time approx. 3 weeks

Stair nosing for renovation

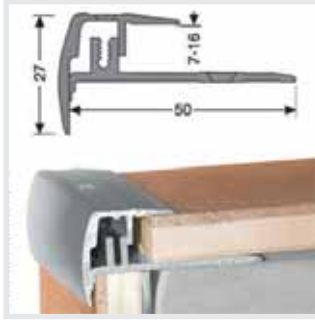

Euro-Step stair nosings type 320

Two-piece, screw-on moulding system. The cover section can be removed at any time and can be precisely readjusted by setting the screws. The wider base section ensures enhanced stability and safety at the edges.

For floor coverings between 7 and 16mm. Aluminium anodised.

	ID N°	PU	Min. quant. f. discount		
silver, length 100 cm	404 946	1 pc.	6 pc.		
silver, length 270 cm	404 945	1 pc.	4 pc.		



Sloping edge type 3402

For the facing of the stair's riser; allows the optimal use of the available tread width.

Only usable in combination with stair nosing Euro-Step model 320. With countersunk holes. Phillips head screws 3.5 x 30 mm enclosed. Aluminium

Length: 100 cm

ID N°	PU	Min. quant. f. discount		
402 492	1 pc.	6 pc.		

Stair nosing for Celenio and DISANO Design Floor

Product line orders

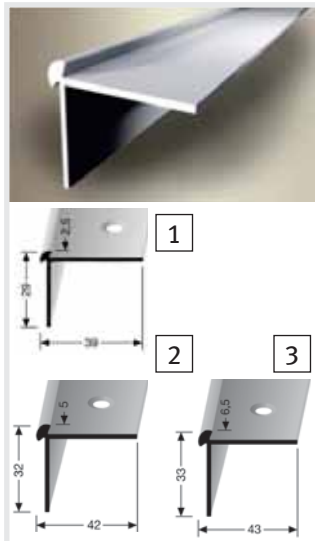

Stair nosing for Celenio and DISANO Design Floor

One-piece stair nosing especially for low floor heights. Screw-mountable and precisely adjustable; can also be glued. Style available in gold, silver, bronze and stainless steel/titan.

Length: 250 cm

Min. quantity f. discount 10 metres

	ID N°	PU	Min. quant. f. discount		
Type 870 for DISANO Project 1	406 276	10 pc.	10 pc.		
Type 873 for DISANO Saphir 2	406 276	10 pc.	10 pc.		
Type 874 for Celenio 3	406 276	10 pc.	10 pc.		



Stair nosing Type 870 EC for DISANO Project

One-piece 90° corner as a supplement for stair nosing profile type 870. For optimal barefoot walking on open stairs. Screw-mountable and precisely adjustable.

Length: 250 cm

Min. quantity f. discount 10 metres

When ordering, please specify whether you need a left or right L-shape. Style available in silver.

	ID N°	PU	Min. quant. f. discount		
Length 30 x 30 cm 1	406 276	10 pc.	10 pc.		
Length 100 x 30 cm 2	406 276	10 pc.	10 pc.		
Length 150 x 30 cm	406 276	10 pc.	10 pc.		

Comfort Line insulation underlays

Product line orders

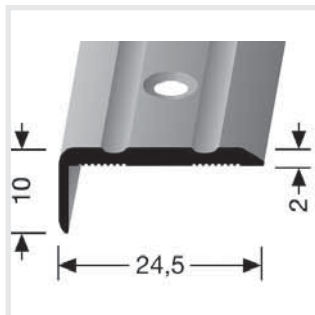

Angled Moulding Type 236

Essential in professional staircase renovation. Ensures safety and protection. The stair nosings are also suitable for spiral staircases and landings, and give the stairs a decorative timeless appearance. Stair nosing with countersunk mounting holes and decorative grooves on one side.

Length: 270 cm

ID N°	PU	Min. quant. f. discount		
406 276	10 pc.	10 pc.		

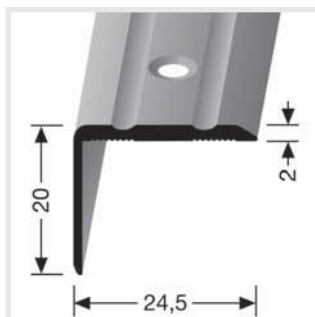

Angled Moulding Type 235

Essential in professional staircase renovation. Ensures safety and protection. The stair nosings are also suitable for spiral staircases and landings, and give the stairs a decorative timeless appearance. Stair nosing with countersunk mounting holes and decorative grooves on one side.

Length: 270 cm

ID N°	PU	Min. quant. f. discount		
406 276	10 pc.	10 pc.		

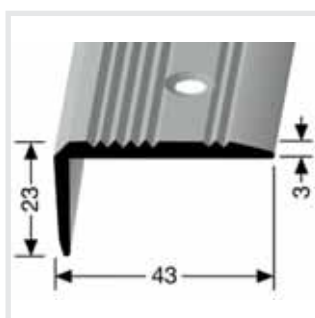

Angled Moulding Type 225

Essential in professional staircase renovation. Ensures safety and protection. The stair nosings are also suitable for spiral staircases and landings, and give the stairs a decorative timeless appearance. Stair nosing with countersunk mounting holes and decorative grooves on one side.

Length: 250 cm

ID N°	PU	Min. quant. f. discount		
406 276	10 pc.	10 pc.		

HARO Side edging

Our accessories range features products for creating a perfectly coordinated look: Pre-engineered solutions for the side edging of stairs fitted with HARO PARQUET stair noses (only suitable for straight flights of stairs).

The order form with further information and the associated mounting instructions are available at www.haro.com/service („Accessories“ product category) or directly via the following QR code:



Tread and riser

For the tread and riser, the desired parquet floor is cut to the required length with mitred edges (left, right or on both sides).

		ID N°	PU	Min. quant. f. discount		
Tread	1	533 185	1 pc.	-		
Riser	2	533 186	1 pc.	-		



Stair nosing with connection (covered width 60 x 60 mm)

The stair noses are delivered in the same length as the treads and risers (incl. the desired mitred edges).

		ID N°	PU	Min. quant. f. discount		
Stair nosing with connection	3	533 187	1 pc.	-		

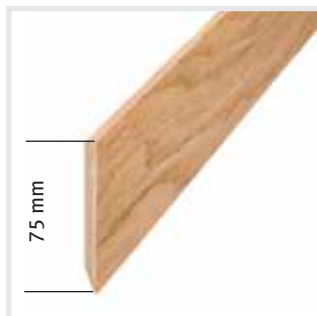

Side edging – cover (height 75 mm)

The side edging is supplied in full plank length, mitred on three edges. The side edging then needs to be cut to size on site.

		ID N°	PU	Min. quant. f. discount		
Side trim panel	4	533 189	1 pc.	-		



clean green
Parkettpflege
natural

clean green
Parkettpflege
aqua oil

clean green
Parkettpflege
active

WOLFF
PARKETT
REPARATUR
MIT
KLEBER

WOLFF
PARKETT
REPARATUR
MIT
KLEBER

Tailor-Made Accessories

Quality and choice for perfect floors

The right accessories make your floor even more valuable, and help you to effortlessly keep it in great shape. From matching skirtings and radiator rosettes through to different mouldings for implementing transitions and concealing expansion joints, we offer you everything for perfectly designing your living areas. Specially formulated for your quality HARO Floor, and needless to say, in HARO brand name quality.

Installation

Insulation Underlays	152
Floor protection	157
Laying Tools	158
Preparing the subfloor	159
Tubular bag adhesive	159
Adhesives	160
Glue	161
Joint Filler	161

Skirtings

Skirtings for Parquets	163
Skirtings for parkettmanufaktur	167
Skirtings for Laminate Floors	168
Skirtings for DISANO	171
Skirtings for Cork Floors	172
Skirtings for CELENIO	172
White skirtings	173
Flexible foam skirting	174
Antique Skirtings	175
Quarter rounds	175
Skirting Accessories	176
LED Skirting	177
Plastic corners	178

Mouldings

PREMIUM Mouldings	181
ALLROUND Mouldings	183
ECO Mouldings	184
CHAMPION STAR Mouldings	185
HDF-Easy Mouldings	186
Real wood floor moulding for parquet	187
ECONOMY Mouldings	188
EURO-CLIP Mouldings	189
Radiator Rosettes	191

Care

clean & green	192
Floor Care Tools	194
Care Products	195
Floor Care Accessories	197

Renovation

Renovation	198
------------------	-----

Insulation Underlays – The strength of tranquility

Requirements for today's insulation underlays

In the system, insulation underlays improve the comfort of your floor.

The right insulation underlay

- ensures quiet in the room and absorbs room and footfall sound.
- improves the elasticity of the floor, reduces impact on the body's joints and increases living comfort.
- smoothes out minor irregularities of the floor, thus improving product safety.
- protects against penetrating moisture from the subfloor.

There is a wide range of insulation underlays on the market, but which is the right one. In order to help you with choosing the right insulation underlay and to evaluate the measured values, here is a brief overview of the most important values to be taken into account.

Footfall and room sound reduction:

The footfall and room sound can be significantly reduced by selecting the floor together with a high-quality insulation underlay. Wooden floors develop a particularly pleasant and duller sound compared to other hard floor coverings. Insulation underlays with a high mass weight (density kg/m²) significantly reduce the generation of sound and sound propagation in the room (sound in the room).

Example of a reduction that meets the highest standards with the Silent Pro insulation layer

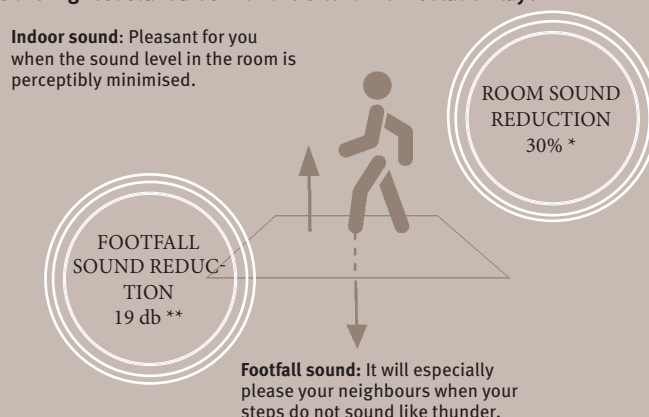

Room and footfall sounds are not directly comparable, as different test procedures/conditions are used. Even seemingly objective room and footfall sound levels are often not comparable due to different test methods. Therefore, you should keep in mind the respective test method when comparing the values and consider room and footfall sound separately.

* Maximum individual values achieved in accordance with the EPLF Impact Hammer test (compared to reference floor)

** According to DIN 140-8

Thermal resistance:

The thermal resistance characterises the ratio of the thickness to the thermal conductivity of a component. The higher the thermal resistance, the better the thermal insulation property of the component or a layer. So if you have an underfloor heating, you must make absolutely sure that the thermal resistance of the insulation underlay is as low as possible. This allows the underfloor heating to work efficiently and thus lowers the heating costs.

Thermal resistance	Thermal conductivity
0,004-0,01 m ² K/W	high
0,01-0,03 m ² K/W	medium
0,03-0,110 m ² K/W	low

Moisture protection:

„Water vapour diffusion-equivalent air layer thickness“ sd value:

The sd value is a value measured in metres (m) and determines the vapour permeability of a building material. The higher the value, the less moisture diffuses (creeps) through the material. To protect against possible residual moisture on newly introduced mineral substrates and all mineral subfloors with underfloor heating, laying out a vapour barrier is necessary. All Haro insulation underlays with an sd value fulfil the standard of a vapour barrier. Here you can choose between an insulation underlay with integrated vapour barrier, such as Silent Pro DS and Silent Energy DS, or the Haro Vapo Stop vapour barrier before laying the insulation underlay.

sd value	Moisture protection
< 0,5 m	low
0,5 m - 1500 m	medium (Moisture protection)
> 1500 m	high (Vapour barrier)

You will also find detailed information in our technical data sheets or receive information by telephone through our application technology service.

Overview

	Silent Double Fix	Silent Pro DS	Silent Pro	Silent Energy DS	Silent Grip	Silent Eco DS	Silent Eco	Roll-out cork underlay	Woodfibre insulation board	Visco Pro DS	Visco Pro	Duofol	EPS Easy Aquastop	Quality PE Foam	Standard PE Foam	Vapo Stop vapour barrier
	COMFORT-LINE					ECO-LINE				BASIC-LINE						
Material thickness (in mm) approx.	2	3	3	1,5	1,4	2	2	2	5	2	2	2,2	1,6	2	2	0,2
Indoor sound reduction	●●●●●	●●●●●	●●●●●	●●●●●	●●●●○	●●●●○	●●●●●	●○○○○	●○○○○	●●●●○	●●●●●	●○○○○	●●●●○	●●○○○	○○○○○	○○○○○
Footfall sound improvement	●●●●●	●●●●○	●●●●○	●●●●●	●●●●○	●●●●○	●●●●○	●●●●○	●●●●●	●●●●●	●●●●○	●○○○○	●●●●○	●●●●○	●●○○○	○○○○○
Levelling out of subfloor irregular.	●●●○○	●●●○○	●●●○○	●●○○○	●●○○○	●●○○○	●●○○○	●●○○○	●●●●●	●●○○○	●●○○○	●○○○○	●○○○○	●○○○○	●○○○○	○○○○○
Underfloor heating compatible	●●●●○	●●●●○	●●●●○	●●●●○	●●●●○	●●●●○	●●●●○	●●●●○	○○○○○	●●●●○	●●●●○	●●●●○	●●●●○	●●●●○	●●●●○	●●●●●
Pressure stability	●●●●○	●●●●○	●●●●○	●●●●○	●●●●○	●●●●○	●●●●○	●●●●○	●●●●○	●●●●○	●●●●○	●○○○○	●●●●○	●●●●○	●○○○○	○○○○○
Heat insulation«	○○○○○	○○○○○	○○○○○	○○○○○	○○○○○	○○○○○	○○○○○	●○○○○	●●●●○	●○○○○	●○○○○	●○○○○	●○○○○	●○○○○	●○○○○	○○○○○
Moisture protection	○○○○○	●●●●○	○○○○○	●●●●○	○○○○○	●●●●○	○○○○○	○○○○○	○○○○○	●●●●○	○○○○○	●●●●○	●●●●○	○○○○○	○○○○○	●●●●○

Properties: ●○○○○ satisfactory
●●○○○ satisfactory
●●●○○ good
●●●●○ excellent
●●●●● excellent

COMFORT: Premium insulation underlay for the highest demands for indoor and footfall sound

ECO: Insulation underlay based on natural raw materials

BASIC: Standard insulation underlay with an excellent price/performance ratio

Comfort Line insulation underlays

Premium insulation underlay for the highest demands for indoor and footfall sound insulation. The high elasticity reduces impact on body joints and the spine.

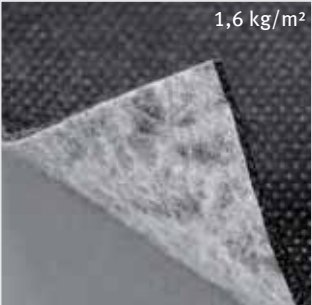

1,6 kg/m²

Silent Double Fix Specially developed for glue-down installation on both sides

High-quality insulation layer with decoupling function, consisting of mineral fillers. Thanks to double-sided glue-down installation beneath parquet, Silent Double Fix achieves the best possible impact sound values (+6 db compared to direct glue-down installation on screed without Silent Double Fix). Also suitable for floating installation and use with underfloor heating.

Thermal resistance 0.010 m² K/W
Thickness: 2 mm
Roll: 7,89x0,95 m
Pallet: 40 rolls = 300 m²

ID N°	PU	Min. quant. f. discount		
410 376	1 roll = 7,5 m ²	40 rolls = 300 m ²		



2,4 kg/m²

Silent Energy DS Ideal for use over underfloor heating

High-quality sound insulation underlay with integrated vapour barrier based on polyolefins filled with natural stone dust. Perfect for use over underfloor heating thanks to its excellent thermal conductivity. Helps save energy.

Thermal resistance 0.004 m² K/W
SD > 200 m
Thickness: 1.5 mm
Roll: 7,4x0,75 m
Pallet: 54 rolls = 299,7 m²

ID N°	PU	Min. quant. f. discount		
408 292	1 roll = 5,55 m ²	54 rolls = 299,7 m ²		

Comfort Line insulation underlays

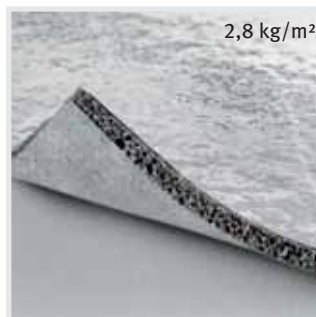
2,8 kg/m²

Silent Pro DS

Exceptional walking comfort with sound insulation and moisture protection

The premium product is of the same make as Silent Pro, but equipped with an additional vapour barrier. Suitable for use over underfloor heating.

Thermal resistance
0.010 m² K/W
SD > 100 m
Thickness: 3 mm
Roll: 5,27x0,95 m
Pallet: 40 rolls = 200 m²

ID N°	PU	Min. quant. f. discount		
405 849	1 roll = 5 m ²	40 rolls = 200 m ²		

2,8 kg/m²

Silent Pro

Excellent sound insulation and walking comfort

Silent Pro based on PUR with mineral fillers ensures the best possible sound conditions. Both the sound in the room and the footfall sound in bordering rooms are considerably reduced. The forest floor effect caused by the high elasticity reduces impact on body joints and spine. Suitable for use over underfloor heating.

Thermal resistance
0.010 m² K/W
Thickness: 3 mm
Roll: 5,27x0,95 m
Pallet: 40 rolls = 200.00 m²

ID N°	PU	Min. quant. f. discount		
405 325	1 roll = 5 m ²	40 rolls = 200 m ²		

1,5 kg/m²

Silent Grip

Specially developed for vinyl and design floor coverings with click system

High-quality acoustic insulation underlay containing mineral fillers with slip-resistant grip surface specially for floating installation of vinyl and design floor coverings with click system. Suitable also for installation over underfloor heating

Thermal resistance
0.010 m² K/W
Compression strength: 44 t
Thickness: 1.4 mm
Roll: 10x0,95 m
Pallet: 40 rolls = 380 m²

ID N°	PU	Min. quant. f. discount		
409 272	1 roll = 9,5 m ²	40 rolls = 380 m ²		

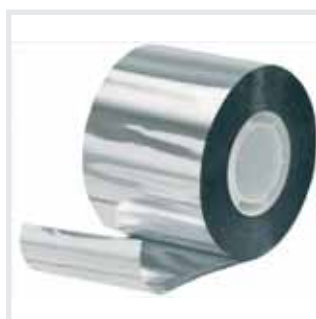

Aluminium adhesive tape

For joining sheets of Silent Pro DS, Silent Eco DS, Visco Pro DS and Duofol footfall sound insulation underlays.

Width: 50 mm
Length: 50.00 m

ID N°	PU	Min. quant. f. discount		
405 851	1 roll	36 rolls		

ECO LINE Insulation Underlays

Insulation underlay based on natural raw materials.



1,7 kg/m²

Silent Eco DS

Eco acoustic mat with moisture protection

High-quality acoustic mat with excellent footfall and room sound properties and integrated vapour barrier; material based on vegetable oils with mineral fillers. The permanently flexible insulation underlay offers added walking comfort and reduces impact on body joints and spine. Suitable for use over underfloor heating.

Thermal resistance
0.010 m² K/W
SD > 100 m
Thickness: 2 mm
Roll: 7,37x0,95 m
Pallet: 40 rolls = 280 m²

ID N°	PU	Min. quant. f. discount		
407 850	1 roll = 7 m ²	40 rolls = 280 m ²		



1,7 kg/m²

Silent Eco

Eco acoustic mat

High-quality acoustic mat with excellent footfall and room sound properties; material based on vegetable oils with mineral fillers. The permanently flexible insulation underlay offers added walking comfort and reduces impact on body joints and spine. Suitable for use over underfloor heating.

Thermal resistance
0.010 m² K/W
Thickness: 2 mm
Roll: 7,37x0,95 m
Pallet: 40 rolls = 280.00 m²

ID N°	PU	Min. quant. f. discount		
407 196	1 roll = 7 m ²	40 rolls = 280 m ²		



0,4 kg/m²

Roll-out cork underlay

Natural cork

This natural insulation underlay made of cork offers an excellent price-performance ratio and is suitable for universal applications; it is even underfloor heating compatible and suitable for use in computer rooms. Very good footfall sound and heat insulation.

Thermal resistance
0.041 m² K/W
Thickness 2 mm
Roll: (10 m²): 10x1 m
Roll (30 m²): 30x1 m
Pallet (10 m²) 350 m²
Pallet (30 m²) 360 m²

ID N°	PU	Min. quant. f. discount		
403 640	1 roll = 10 m ²	35 rolls = 350 m ²		
402 847	1 roll = 30 m ²	12 rolls = 360 m ²		

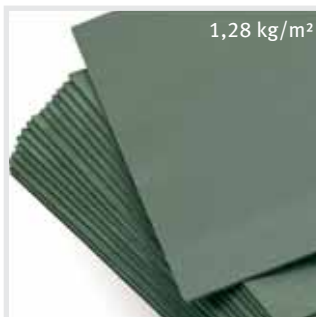

1,28 kg/m²

Woodfibre insulation board

Excellent heat insulation

Levelling, footfall-sound and heat insulation underlay made of FSC® (CO21181) -certified natural wood fibre. Meets high ecological requirements. Due to its thermal resistance and excellent insulation properties, this underlay is not recommended for use over underfloor heating. Helps save energy.

Thermal resistance
0.071 m² K/W
Thickness 5 mm
Dimensions (board) 0,79x0,59 m
Pallet: 24 pack = 168.00 m²

ID N°	PU	Min. quant. f. discount		
406 354	1 pack = 7m ²	24 pack = 168 m ²		

BASIC LINE Insulation Underlays

Standard insulation underlay with an excellent price-performance ratio improves walking comfort and reduces footfall sound.



0,2 kg/m²

Visco Pro DS

Light insulation underlay for reduced sound and moisture protection

The light insulation underlay for reduced sound, with integrated vapour barrier. With its high viscoelasticity, this 2 mm (3/32") thick levelling underlay can adapt optimally to the subfloor and smooth out irregularities almost completely. Despite its light weight (230 g/m²), Visco Pro has excellent indoor and footfall sound reduction properties and is also perfect for use over underfloor heating.

Thermal resistance
0.041 m² K/W
SD > 100 m
Thickness: 2 mm
Roll: 15,2x0,99 m
Palett: 24 rolls = 360 m²

ID N°	PU	Min. quant. f. discount		
407 721	1 roll = 15 m ²	24 rolls = 360 m ²		



0,2 kg/m²

Visco Pro

Light insulation underlay for reduced sound

The light insulation underlay for reduced sound. With its high viscoelasticity, this 2 mm (3/32") thick levelling underlay can adapt optimally to the subfloor and smooth out irregularities almost completely. Despite its light weight (200 g/m²), Visco Pro has excellent indoor and footfall sound reduction properties and is also perfect for use over underfloor heating.

Thermal resistance
0.039 m² K/W
Thickness: 2 mm
Roll: 15,2x0,99 m
Palett: 24 rolls = 360 m²

ID N°	PU	Min. quant. f. discount		
407 720	1 roll = 15 m ²	24 rolls = 360 m ²		



0,14 kg/m²

Duofol PE footfall sound insulation

Combination of 2 mm standard PE foam and 0.2 mm PE construction film. The overlap strip of the PE film along the side provides added protection against moisture penetration. Due to possible electrostatic charging, this insulation underlay should not be installed under laminate flooring in rooms in which computer systems are used. Only suitable for use over underfloor heating if installed under laminate floor.

1.00 m width + 6 cm overlapping adhesive strip

Thermal resistance
0.040 m² K/W
SD > 100 m
Thickness: 2.2 mm
Roll: 28,8x1,06 m
Pallet: 12 rolls = 345,6 m²

ID N°	PU	Min. quant. f. discount		
402 053	1 roll = 28,8 m ²	12 rolls = 345,6 m ²		

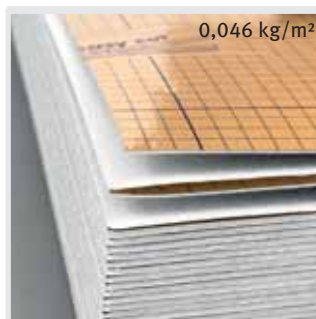

0,046 kg/m²

EPS Easy Aquastop (fanfold board)

Very easy to install fanfold board made of expanded polystyrene foam; with integrated vapour barrier and aluminium tape.

Thermal resistance
0.040 m² K/W
SD > 100 m
Thickness: 1.6 mm
format: 15x1,2 m
pallet: 21 pack = 378 m²

ID N°	PU	Min. quant. f. discount		
407 719	1 pack = 18 m ²	21 pack = 378 m ²		



0,14 kg/m²

Quality PE Foam

High-quality, non-crosslinked PE foam for application areas with increased traffic and load. Due to possible electrostatic charging, this insulation underlay should not be installed under laminate flooring in rooms in which computer systems are used. Only suitable for use over underfloor heating if installed under laminate floor.

Thermal resistance
0.040 m² K/W
Thickness: 2 mm
Roll: 31,6x0,95 m
pallet: 12 rolls = 360.00 m²

ID N°	PU	Min. quant. f. discount		
400 006	1 roll = 30 m ²	12 rolls = 360 m ²		

BASIC LINE Insulation Underlays



0,04 kg/m²

Standard PE Foam

Cost-effective, non-crosslinked PE foam which is suitable for low to medium traffic and load. Due to possible electrostatic charging, this insulation underlay should not be installed under laminate flooring in rooms in which computer systems are used. Only suitable for use over underfloor heating if installed under laminate floor.

Thermal resistance
0.040 m² K/W
Thickness: 2 mm
Roll: 31,6x0,95 m
Pallet: 12 rolls = 360.00 m²

ID N°	PU	Min. quant. f. discount		
403 302	1 roll = 30 m ²	12 rolls = 360 m ²		



HARO Vapo Stop vapour barrier

Provides added moisture protection and should be installed under all insulation underlays that have no integrated vapour barrier. Penetration of residual moisture from the subfloor is prevented and the floor covering is protected against possible moisture damage. Suitable for use over underfloor heating.

SD > 90 m
Thickness: 0.2 mm
Roll: 13x2 m
Pallet: 83 rolls = 2158 m²

ID N°	PU	Min. quant. f. discount		
406 208	1 roll = 26 m ²	20 rolls = 520 m ²		



www.blaue-engel.de/uz30a

Floor protection

For the protection of your floor, for example during renovation work and when moving house



NEW

HARO Protective fleece

Multifunctional anti-slip protection and protective fleece. The HARO Protective fleece is equipped with a non-slip underside and a waterproof foil. The ideal solution to protect floors and stairs. For use on dry surfaces subject to low to moderate mechanical strain.

Thickness: 1.3 mm
Roll: 50x1 m
Palett: 24 rolls = 1200 m²

ID N°	PU	Min. quant. f. discount		
410 633	1 roll = 50 m ²	12 rolls = 600 m ²		

Laying Tools

From tapping block to pull tool: installation tools from the HARO range meet professional requirements. To be able to guarantee optimum product harmonization, we also develop our own tools in close cooperation with leading manufacturers.



All-round tapping block

Tapping block made of extremely durable recycled PE plastic

Length: 28.00 cm

ID N°	PU	Min. quant. f. discount		
405 712	1 pc.	4 pc.		



Tapping block LC Plus

Made of extremely durable recycled PE plastic. For floating installation of HARO floorings with Lock Connect plus installation system

Length: 30.00 cm

ID N°	PU	Min. quant. f. discount		
406 586	1 pc.	10 pc.		



Professional tapping block

Made of extremely durable recycled PE plastic. With its slightly bevelled tapping edge, it offers an ideal striking surface.

Length: 30.00 cm

ID N°	PU	Min. quant. f. discount		
404 455	1 pc.	10 pc.		



Hammer 800 g

Due to its technical properties especially recommended for the installation of Lock Connect.

ID N°	PU	Min. quant. f. discount		
403 970 *	1 pc.	6 pc.		

* While stocks last



PVA Distance spacer

Steplessly adjustable plastic spacers for reliably and precisely setting the necessary expansion space from the surrounding walls. The mechanism prevents the spacer from slipping out of the expansion joint.

ID N°	PU	Min. quant. f. discount		
400 358	1 pc.	6 pc.		



Distance spacers

Steplessly adjustable plastic spacers for expansion joints between 8 and 20 mm.

28 pc.

ID N°	PU	Min. quant. f. discount		
403 126	1 pack	40 pack		



Professional pull tool PLUS

Extra quiet professional pull tool. Sound reduction through exchangeable hard rubber striking face.

Length: 52.00 cm

ID N°	PU	Min. quant. f. discount		
405 993	1 pc.	5 pc.		



Buffer model f. professional pull tool PLUS

Rubber top for professional pull tool Plus

Content: 5 pc.

ID N°	PU	Min. quant. f. discount		
405 994	1 bag	10 bag		

Preparing the subfloor

Subfloor preparation for installation of HARO flooring with ComforTec backing.



NEW

HARO Primer

Adhesion primer for mineral subfloors for ComforTec installation and beneath HARO Flexible Glue.

1 l content, sufficient for approx. 6 sq.m.
10 l sufficient for approx. 60 sq.m. depending on the subfloor

	ID N°	PU	Min. quant. f. discount		
1 litre	410 567	1 pc.	12 pc.		
10 litres	410 588	1 pc.	10 pc.		

Tubular bag adhesive

Product line orders

For a fast and ergonomically ideal application of parquet adhesive in a standing position.



NEW

HARO Tubular bag adhesive

Product line orders

Very low-emission (EC1 plus R classified), solvent-free, elastically hardening Tubular bag adhesive for the installation of parquet floors. Suitable for use on underfloor heating.

Coverage: approx. 500 ml/m²
Palett: 84 pieces = 647 kg

ID N°	PU	Min. quant. f. discount		
410 586	1 pc. = 7,7 kg	-		



NEW

Applicator for HARO Tubular bag adhesive

Product line orders

Battery-operated applicator gun for application of HARO Tubular bag adhesive. The applicator comes in a case and is equipped with a 200 mm distributor head to accommodate interchangeable nozzles, a quick charger, two 18 volt batteries, and a stand.

Product line order

Delivery time approx. 2 weeks

ID N°	PU	Min. quant. f. discount		
410 614	1 pc.	-		

Interchangeable nozzles for the applicator

Product line orders

Distributor head 200 mm, selectable width, nozzle with 11 or 18 holes
Distributor head 400 mm, selectable width, nozzle with 25 or 40 holes

	ID N°	PU	Min. quant. f. discount		
Interchangeable nozzles to choose from	410 733	1 pc.	-		

Adhesives



HARO Flexible Glue

Solvent-free and water-free 1-component adhesive for glue-down installation of Parquet, Design Floor DISANO Classic Aqua, SmartAqua and Saphir; remains flexible after hardening, is ready to use, and has very low emissions (EC1 classified). Suitable for use over underfloor heating.

Coverage:
16 Pallet (18 kg):
792 kg / 44 pcs.
Pallet (9 kg):
648 kg / 72 pcs.

ID N°	PU	Min. quant. f. discount		
410 563	1 pc. = 18 kg	4 pc. = 72 kg		
410 565	1 pc. = 9 kg	12 pc. = 108 kg		



Dispersion Adhesive

for the HARO Design Floor DISANO Project, homogeneous PVC and CV floorings
Solvent-free one-side dispersion adhesive with very low emission levels (EC1 classified). Suitable for use over underfloor heating.

Coverage: approx. 300 g/sq.m.
Pallet: 462 kg / 33 pcs.

ID N°	PU	Min. quant. f. discount		
410 566	1 pc. = 14 kg	5 pc. = 70 kg		



Special spreader L for 3-layer Parquet and selected Design Floors

Especially suitable for applying HARO Flexible Glue when installing 3-layer Parquet, Design Floors DISANO Classic Aqua

5.5 mm deep notches

ID N°	PU	Min. quant. f. discount		
400 464	1 pc.	10 pc.		



Special spreader D for 2-layer parquet and selected Design Floors

Especially suitable for applying HARO Flexible Glue when installing 2-layer Parquet, Design Floor SmartAqua and Saphir.

4 mm deep notches.

ID N°	PU	Min. quant. f. discount		
400 529	1 pc.	10 pc.		



Special spreader for Disano Project

Especially suitable for spreading HARO dispersion adhesive when installing HARO Disano Project Design Floor.

1.5 mm deep notches

ID N°	PU	Min. quant. f. discount		
409 682	1 pc.	10 pc.		



HARO mounting adhesive

- Very good initial adhesion
- Permanently elastic, odourless curing
- Solvent free, silicone free, isocyanate free, free from plasticising ingredients
- Versatile, e.g. for HARO Interior Wall and Stairs, skirtings and mouldings

Content: 310 ml
Coverage: approx. 1 m²

ID N°	PU	Min. quant. f. discount		
409 847	1 pc.	12 pc.		

Glue



PVAC-D3 White Glue

For waterproof gluing of wood joints (tongue/groove)

Content per bag 550.00 g
Coverage: approx. 25.00 m²

ID N°	PU	Min. quant. f. discount		
403 125	1 pc.	12 pc.		

Joint Filler



Couling cork - solvent free

Universal, high-grade caulking and filling agent for heat and sound insulation. Consists of purely natural granulated cork and a solvent-free, elastic binding agent. The material is a single-component product; it is viscoplastic and stable.

Content per bag: 500 ml

ID N°	PU	Min. quant. f. discount		
406 088	1 pc.	20 pc.		



Joint Filler

Single-component, rigid and permanently elastic, acrylic-based sealing compound. Silicone-free, solvent-free, non-odorous and easy to sand. Contents: per cartridge: 310 ml
Can be finished. Also suitable for use as an adhesive due to its high adhesive strength. Frost-sensitive.

Colour	ID N°	PU	Min. quant. f. discount		
Beech Light/Maple	405 720	1 pc.	12 pc.		
Oak / Smoked Oak	405 723	1 pc.	12 pc.		

Skirtings for that perfect holistic look

The choice is yours: with laminate cover or veneer. Matching the floor or as a contrast. When it comes to your imagination, the sky is the limit!

Matching skirtings for your floor

Skirtings for	surface material	Construction
Oiled Parquet	● Solid / Veneer / Veneer brushed	Solid / Solid wood core / MDF core
Parquet naturaDur	● Veneer / Veneer brushed	Solid wood core / MDF core
Prefinished matt Parquet	● Veneer / Veneer brushed	Solid wood core / MDF core
Laminate Floor	● Style foil / Laminate cover textured	MDF core / Solid wood core resistant to water
Design floor DISANO	● Style foil	MDF core / Solid wood core resistant to water
Cork Floor	● Style foil / Prefinished matt veneer	MDF core / Solid wood core
CELENIO	● Style foil	MDF core

Skirtings Classic - with and without recess for clips						Skirtings Cube - with and without recess for clips			
19 x 39S mm	19 x 39 mm	19 x 58 mm	20 x 55 mm	19 x 38 mm	14 x 14 mm	16 x 40 mm	16 x 58 mm	16 x 58 mm	15 x 80 mm
● ●	● ● ●	● ● ● ●	●	●	●	●	●	● ●	● ●

White skirtings - universally applicable

Skirtings	Finish / Properties	recommended
White - Solid wood core	extra strong foil for high opacity, paintable / resistant to water / painted wood texture	Parquet
White - MDF core with laminate cover	white foil, paintable / white foil textured	Laminate Floor
White - PS foam	white PS foam smooth- waterproof	all floors, especially in damp rooms
White - MDF „Antique design“	white foil, paintable / white finished	all floors

Skirtings Classic - with and without recess for clips		Skirtings Cube - with and without recess for clips			Skirtings white, PS foam waterproof		Antique stick-on skirtings			Accessories			
19 x 58 mm	14 x 14 mm	16 x 40 mm	16 x 58 mm	16 x 58 mm with insulation strips	16 x 40 mm	16 x 58 mm	15 x 80 mm	18 x 70 mm	18 x 90 mm	18 x 115 mm	Clips for stick-on skirtings	HARO Nail clip	Seal lip rail

Skirtings for Parquet Oiled Classic - with recess for clips

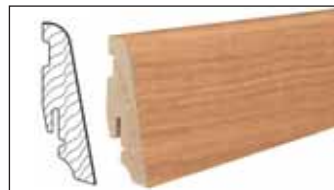

Stick-on skirtings with solid wood core, veneered, oiled, 19 x 58 mm

Length: 220 cm



Stick-on skirtings with solid wood core, veneered, oiled 19x39S mm

Length: 250 cm



Stick-on skirtings with solid wood core, veneered, oiled, 19 x 39 mm

Length: 220 cm

PU: 1 piece
Min. quant. for discount: 10 piece
Packaging: 10 pcs./ bundle packaged in film

Wood species	ID N°			ID N°			ID N°		
African Oak	406 894								
African Oak brushed	409 610								
Smoked Oak	406 893			408 664			406 913		
Smoked Oak brushed	409 611								
Beech Steamed	406 891			408 662 ¹			406 911		
Beech Steamed brushed	409 786								
Oak	406 890			408 663			406 910		
Oak Atelier	409 042								
Oak with branch knots	NEW 410 713								
Oak Creme White	410 036								
Oak Invisible	409 733			410 701			410 704		
Oak Crystal White	410 707								
Oak Shell Grey	410 711								
Oak Nutmeg Brown	409 723								
Oak Puro White	406 907			410 703			410 706		
Oak Puro White brushed	409 613								
Oak Velvet Brown	409 703			410 136					
Oak Sand Grey	409 734								
Oak Sand Grey brushed	409 785								
Oak Sand White / Ash Sand White	409 349			410 702			410 705		
Oak Sand White / Ash Sand White brushed	409 789								
Oak Reed Brown	410 712								
Oak brushed	409 612								
Oak Tobacco Grey	408 680								
Ash Fancy	408 682								
Larch	406 898						406 917		
Larch Puro White	407 189								
Larch Tobacco Grey	410 156								
Walnut	406 896			408 666 ¹					
Fumed Oak	410 708								
Fumed Oak Invisible	410 710								
Fumed Oak Puro White	410 709								
Thermo Ash Mezzo	406 901								
Thermo Oak Forte	406 899								
Wenge	406 906								

¹ While stocks last

Skirtings for Parquet Oiled Classic Solid - without recess for clips



PU: 1 piece
Minimum quantity for discount: 10 piece
Packaging: 10 pcs./bundle packaged in film

Wood species	ID N°		
African Oak	406 455		
Smoked Oak	406 454		
Oak	406 453		

Skirtings for Parquet Oiled Cube - with recess for clips

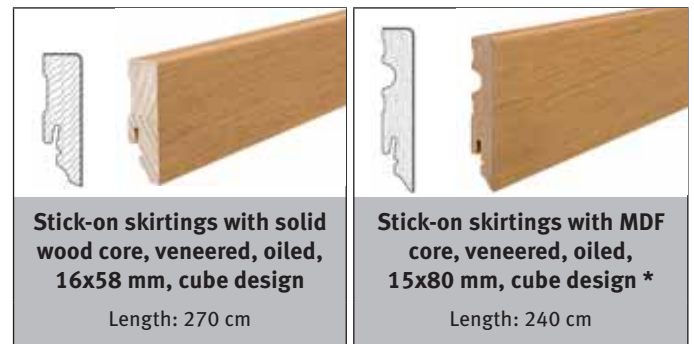

PU: 1 piece
Minimum quantity for discount: 10 piece
Packaging: 10 pcs./bundle packaged in film

Wood species	ID N°			ID N°		
Smoked Oak	409 354					
Oak	409 355			409 357		
Oak with branch knots	NEW 410 717					
Oak Creme White	410 714					
Oak Invisible	410 715			410 718		
Oak Puro White	409 356			409 358		
Oak Tobacco Grey	410 716					
Oak Sand White / Ash Sand White				410 719		

Note on installation:
Suitable for expansion joints of up to 10 mm to the wall!

Skirtings for Parquet Oiled Cube - without recess for clips

FOR COMMERCIAL APPLICATIONS



PU: 1 piece
Minimum quantity for discount: 10 piece
Packaging: 10 pcs./bundle packaged in film

Wood species	ID N°			ID N°		
Oak	410 642			410 645		
Oak Puro White	410 643			410 646		
Oak Sand White / Ash Sand White	410 644			410 647		

Skirtings for Parquet naturaDur Classic - with recess for clips

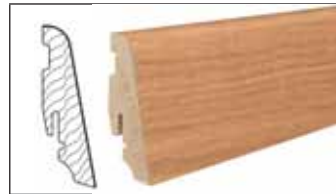

Stick-on skirtings with solid wood core, veneered, oiled, 19 x 58 mm

Length: 220 cm

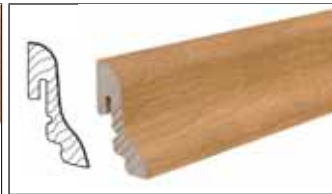

Stick-on skirtings with solid wood core, veneered, oiled 19x395 mm

Length: 250 cm



Stick-on skirtings with solid wood core, veneered, oiled, 19 x 39 mm

Length: 220 cm

PU: 1 piece
Min. quant. for discount: 10 piece
Packaging: 10 pcs./
bundle packaged in film

Wood species	ID N°		ID N°		ID N°		
Smoked Oak	406 893		408 664		406 913		
Smoked Oak brushed	409 611						
Beech Steamed	406 891		408 662 ¹		406 911		
Beech Steamed brushed	409 786						
Oak	406 890		408 663		406 910		
Oak Invisible	409 733		410 701		410 704		
Oak Puro White	406 907		410 703		410 706		
Oak Puro White brushed	409 613						
Oak Sand Grey	409 734						
Oak Sand Grey brushed	409 785						
Oak Sand White / Ash Sand White	409 349		410 702		410 705		
Oak Sand White / Ash Sand White brushed	409 789						
Oak brushed	409 612						
Walnut	406 896		408 666 ¹				

¹ While stocks last

Skirtings for Parquet naturaDur Cube - with recess for clips



Stick-on skirtings with solid wood core, veneered, oiled, 16x58 mm, cube design

Length: 270 cm



Stick-on skirtings with MDF core, veneered, oiled, 15x80 mm, cube design*

Length: 240 cm

PU: 1 piece
Minimum quantity for discount: 10 piece
Packaging: 10 pcs./bundle packaged in film

Wood species	ID N°			ID N°			
Smoked Oak	409 354						
Oak	409 355			409 357			
Oak Invisible	410 715			410 718			
Oak Puro White	409 356			409 358			
Oak Sand White / Ash Sand White				410 719			

Note on installation:
Suitable for expansion joints of up to 10 mm to the wall!

Skirtings for Parquet prefinished Classic - with recess for clips



Stick-on skirtings with solid wood core, veneered, matt finished, 19x58 mm

Length: 220 cm



Stick-on skirtings with solid wood core, veneered, matt finished, 19x39S mm

Length: 250 cm

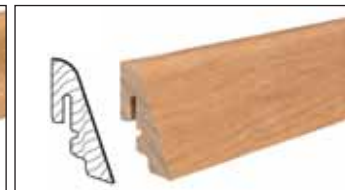

Stick-on skirtings with solid wood core, veneered, matt finished, 19x39 mm

Length: 220 cm

PU: 1 piece
Min. quant. for discount: 10 piece
Packaging: 10 pcs./ bundle packaged in film

Wood species	ID N°		ID N°			ID N°		
African Oak	406 933		408 672 ¹			406 958 ¹		
Maple	406 925		408 667			406 952		
Smoked Oak	406 932		408 671			406 957		
Amber Robinia	406 937					406 960 ¹		
Beech Steamed	406 923		408 668			406 950		
Oak	406 922		408 669			406 949		
Oak Invisible	410 725		410 721			410 723		
Oak Light White	409 044		410 734			409 043		
Oak Light White brushed	409 614							
Oak Puro White	410 724		410 720			410 722		
Oak Sand Grey	410 726							
Oak brushed	409 616							
Ash	406 926		408 673					
Ash Light White	409 045							
Cherry	406 928		408 675					
Merbau	406 930							
Walnut	406 931		408 676			406 956		
Aluminium/MDF core	405 705							

¹ While stocks last

Skirtings for Parquet prefinished Classic Solid - without recess for clips

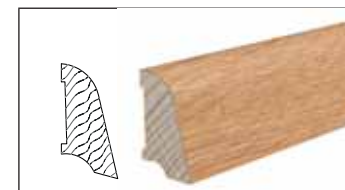

Skirtings with solid wood core, veneered, matt finished, 19x38 mm

Length: 250 cm

PU: 1 piece
Minimum quantity for discount: 10 piece
Packaging: 10 pcs./bundle packaged in film

Wood species	ID N°		
Maple	408 024		
Beech Steamed	408 023		
Oak	408 022		
Walnut	408 025 ¹		

¹ While stocks last

Skirtings for Parquet prefinished Cube - with recess for clips

PU: 1 piece

Minimum quantity for discount: 10 piece

Packaging: 10 pcs./bundle packaged in film



Stick-on skirtings with solid wood core, veneered, matt finished, 16x58 mm, cube design

Length: 270 cm



Stick-on skirtings with MDF core, veneered, prefinished matt, 15x80 mm, cube design *

Length: 240 cm

Wood species	ID N°			ID N°		
African Oak	407 743 ¹					
Maple	407 739			407 437 ¹		
Smoked Oak	407 742					
Beech Steamed	407 740			407 436		
Oak	407 741			407 433		
Oak Invisible	410 728			410 730		
Oak Light White	410 735			408 505		
Oak Puro White	410 727			410 729		
Ash	410 736					
Cherry	410 737					
Walnut	407 744			407 439 ¹		
Aluminium/MDF core	407 745 ¹					

Note on installation: Suitable for expansion joints of up to 10 mm to the wall!

¹ While stocks last

Skirtings for Parquet prefinished Cube - without recess for clips

PU: 1 piece

Minimum quantity for discount: 10 piece

Packaging: 10 pcs./bundle packaged in film

FOR COMMERCIAL APPLICATIONS

NEW



Skirtings without recess, veneered, oiled, 16x40 mm (Cube)

Length: 250 cm

NEW



Skirtings without recess, veneered, matt finish, 16x58 mm (Cube)

Length: 270 cm

Wood species	ID N°			ID N°		
Oak	410 648			410 651		
Oak Light White	410 650			410 653		
Oak Puro White	410 649			410 652		

Skirtings for parkettmanufaktur

PU: 1 piece

Minimum quantity for discount: 10 piece

Packaging: 10 pcs./bundle packaged in film

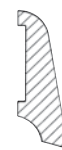

Solid wood skirtings, oiled, 20x55 mm

Length: 240 cm

Wood species	ID N°		
Oak	406 453		
Oak Barrique	408 688		
Oak Carbon Black	408 741		
Oak White Barrique	409 025		
Ash Barrique	408 689		
Ash Olive Grey	408 690		
Amber Smoked Oak	407 626		

Skirtings for Laminate Floors

PU: 1 piece
 Mini. quantity for discount: 10 piece
 Packaging: 10 pcs./bundle
 packaged in film

Prices €/lm excl. VAT

				
Stick-on skirtings, MDF core with laminate cover, 19x58 mm	Stick-on skirtings, MDF core with laminate cover, 19x39S mm	Stick-on skirtings, MDF core with laminate cover, 19x39 mm	Stick-on skirtings, MDF core with laminate cover, 16x58 mm, cube design	Stick-on skirtings, MDF core with laminate cover, 15x80 mm, cube design *
Length: 220 cm	Length: 240 cm	Length: 220 cm	Length: 270 cm	Length: 240 cm

Style	ID N°	ID N°	ID N°	ID N°	ID N°
Maple Akzent	406 821	408 563	406 862 ¹		
Alabama Oak	406 818	408 573	409 291		
Alpine Oak Grey	407 814				408 269
Alpine Oak Nature / Oak Emilia Honey	408 616	408 571	408 590	408 622	408 641
Beech Beige	408 614	408 567	408 588 ¹		
Design Wood Harmony	409 813		410 744		
Vintage Oak	407 816				408 646
Oak Antique Grey / Oak Bergamo Carbon	407 808				408 259
Oak Bergamo Antique Smoked	410 758				410 780
Oak Bergamo Antique White	410 759		410 751		
Oak Bergamo Silver Grey	410 754				410 777
Oak Contura Smoked	410 760				410 781
Oak Contura Black	409 327				409 341
Oak Contura Stone Grey/Highland Oak	407 815	409 792	407 788		409 106
Oak Corona	409 808		409 801		
Oak Dolomiti	408 605		408 581		409 820 ¹
Oak Elegance	408 617				408 642
Oak Emilia Light Grey	410 761		410 752		410 782
Oak Emilia Puro / Oak Olbia	410 755	410 738	410 745	410 772	410 778
Oak Emilia Velvet Brown	410 763				410 784
Oak Emilia Velvet Grey	410 765			410 776	410 786
Oak Emilia Velvet White	410 762				410 783
Oak Emilia White	410 764				410 785
Oak Engadin/Oak Verano	409 317	409 289	409 301		409 336 ¹
Oak Italica Creme	408 608	409 285	408 584	410 773	409 105
Oak Italica Smoked	408 607				408 633
Oak Italica Nature	408 609				408 634
Oak Smoked Heartwood/ Oak Portland Amber	409 183		409 297		409 329
Oak Liguria Greige	410 767				410 787
Oak Livorno Smoked	410 768		410 753		
Oak Melina Puro	409 814		410 746		
Oak Meran	409 806	409 793	409 799		



¹ While stocks last

* Note on installation: Suitable for expansion joints of up to 10 mm to the wall!

Skirtings for Laminate Floors

PU: 1 piece
 Mini. quantity for discount: 10 piece
 Packaging: 10 pcs./bundle packaged in film

Prices €/lm excl. VAT

				
Stick-on skirtings, MDF core with laminate cover, 19x58 mm	Stick-on skirtings, MDF core with laminate cover, 19x39S mm	Stick-on skirtings, MDF core with laminate cover, 19x39 mm	Stick-on skirtings, MDF core with laminate cover, 16x58 mm, cube design	Stick-on skirtings, MDF core with laminate cover, 15x80 mm, cube design *
Length: 220 cm	Length: 240 cm	Length: 220 cm	Length: 270 cm	Length: 240 cm

Style	ID N°	ID N°	ID N°	ID N°	ID N°
Oak Portland Grey	409 321				409 337
Oak Portland Nature	409 322		409 305	410 774	409 338
Oak Portland Puro / Oak Premium Creme	407 800	410 740	409 797	410 775	408 260
Oak Savona Nature	410 756		410 748		
Oak Savona White	410 757		410 749		
Oak Sicilia Puro	410 404				
Oak Sicilia White	410 405				
Oak Siena Puro	410 769	410 742			
Oak Siena Velvet White	410 770	410 743			
Oak Terana / Oak Sicilia Nature / Oak Bergamo Nature / Oak Modena	408 618	410 739	410 747		408 651
Oak Tivoli	410 766	410 741			
Oak Veneto Crema	409 320		409 304		409 819
Oak Veneto Honey	410 406				
Oak Veneto Mocca / Oak Dover / Oak Liguria Greige	409 319	409 790	409 303		
Oak Veneto Sand	409 817				409 826 ¹
Graphite Oak	408 593	408 954	409 293		
Iroko / Afromosia	408 620				408 654
Italian Walnut	407 820		407 790 ¹		408 653
Chestnut Bianco	409 311				409 332
Chestnut Impreso	407 818	408 576 ¹			408 650
Walnut Ambiente	409 313	409 288	409 300 ¹		409 821 ¹
Scandinavian Oak	409 809		410 750		410 779
Holm Oak	406 847	408 569	406 877		
StoneWood Creme	410 771				410 788
Sycamore maple	406 822	408 565	406 863 ¹		408 636

¹ While stocks last

* Note on installation:
 Suitable for expansion joints of up to 10 mm to the wall!

Skirtings for Laminate Floors - brushed

PU: 1 piece
Minimum quantity for discount: 10 piece
Packaging: 10 pcs./bundle packaged in film



Stick-on skirtings, MDF core with
laminate cover,
19x58 mm

Length: 220 cm

Style	ID N°		
Alpine Oak Nature / Oak Emilia Honey - brushed	409 804		
Oak Italica Creme - brushed	409 803		

Skirtings for laminate floors solid wood core - resistant to water (suitable for TRITTY 200 Aqua)

PU: 1 piece
Minimum quantity for discount: 10 piece
Packaging: 10 pcs./bundle packaged in film



Stick-on skirtings with solid wood
core, water-resistant,
15x80 mm (Cube)

Length: 240 cm

Style	ID N°		
Oak Emilia Velvet White	410 822		
Oak Portland Puro	410 823		
Oak Sicilia Nature	410 401		
Oak Sicilia Puro	410 400		
Oak Sicilia White	410 398		
Oak Veneto Honey	410 402		
Oak Veneto Mocca	410 403		
Oak Veneto Sand	410 399		

Skirtings for DISANO



Stick-on skirtings with solid wood core, with laminate cover, water-resistant, 19x58 mm

Length: 220 cm



Stick-on skirtings, MDF core with laminate cover, 19x58 mm

Length: 220 cm

PU: 1 piece

Minimum quantity for discount: 10 piece

Packaging: 10 pcs./bundle packaged in film

Style	ID N°			ID N°		
Artdesign Crema	410 793					
Oak Antique Creme	410 358			410 084		
Antique Oak Smoked	410 365			410 086		
Mountain Oak	409 401					
Concrete Grey	410 796					
Concrete Light	410 795					
Country Oak Grey	410 091					
Country Oak Nature	410 092					
Oak Cambridge				410 087		
Oak Columbia Grey	410 360			409 621		
Oak Columbia Light	410 361			409 619		
Oak Columbia Nature	410 363			409 620		
Oak Glacier	409 415					
Oak Jubilé	410 359			409 666		
Oak Lavida	410 425			410 085		
Oak Nature	410 096					
Oak Natural White	410 357			409 623		
Oak Oxford	410 364			410 290		
Oak Phoenix	410 362					
Oak Provence Creme	410 789					
Oak Provence Smoked	410 791					
Oak Provence Nature	410 790					
Oak Riva	409 413					
Vintage Oak Greige	410 090					
Oak White	410 097					
Field Oak	410 093					
French Smoked Oak	409 406					
Crystal Oak	410 088					
Light Oak	410 089					
Walnut	410 095					
Pine Nordica	409 407					
Sandstone	410 794					
Sand Oak	409 409					
Slate Anthrazit	410 797					
Holm Oak Creme	409 410					
Tobacco Oak	410 094					
Wild Oak	409 412					
white (for Marble white)	410 792					

Skirtings for Cork



Cork Floor stick on skirtings with solid wood core, veneered, varnished/MDF core with laminate cover 19x39 mm

Length: 220 cm

PU: 1 piece

Minimum quantity for discount: 10 piece

Packaging: 10 pcs./bundle packaged in film

Style	ID N°		
Arcos Antique White	406 990		
Arteo Oak Duna	409 058 *		
Arteo Oak Italica Smoked	409 056 *		
Arteo Oak Italica Nature	409 057 *		
Arteo Oak Portland Dark Grey	410 413 *		
Arteo Oak Portland Invisible	410 414 *		
Arteo Oak Portland Naturell	410 412 *		
Arteo Oak Portland White	410 415 *		
Arteo Shabby Oak Grey	410 416 *		
Arteo Shabby Oak Invisible	410 417 *		
Arteo Shabby Oak White	410 418 *		
Lagos/Ronda/Sirio Natur	410 798		
Toledo/Sirio Creme	406 991		

* MDF core with laminate cover

Skirtings for CELENIO



Stick-on skirtings, MDF core with laminate cover, 19x58 mm

Length: 220 cm

PU: 1 piece

Minimum quantity for discount: 10 piece

Packaging: 10 pcs./bundle packaged in film

Style	ID N°		
Atrium anthrazit	406 964		
Athos Achat	406 968		
Athos Concrete Grey	408 224		
Athos ferro	406 972		
Athos Polar Grey	406 973		
Athos Sahara	406 971		
Athos Savanna	408 222		
Ardesia onyx	406 977		

Skirtings white for Parquet with recess for clips

			
<p>Stick-on skirtings with solid wood core, veneered, strong, matt look, 16x40 mm, cube design</p> <p>Length: 250 cm</p>	<p>Stick-on skirtings with solid wood core, veneered, strong, matt look, 19x58 mm</p> <p>Length: 220 cm</p>	<p>Stick-on skirtings with solid wood core, veneered, strong, matt look, 16x58 mm, cube design</p> <p>Length: 270 cm 240 cm²</p>	<p>Stick-on skirtings with solid wood core, strong lam. cover, matt look, 15x80 mm, cube design</p> <p>Length: 240 cm</p>

PU: 1 piece
Mini. quant. for discount: 10 piece
Packaging: 10 pcs./bundle packaged in film

Prices €/lm

	ID N°			ID N°			ID N°			ID N°		
white laminate cover, strong ¹	409 776			409 834			409 835			409 836		
white laminate cover, strong, resistant to water * NEW	410 636			410 792			410 637					
white finished, wood texture NEW							410 640 ²					

¹ Paintable (e.g. to match the wall paint)

Skirtings white for Parquet without recess for clips

FOR COMMERCIAL APPLICATIONS

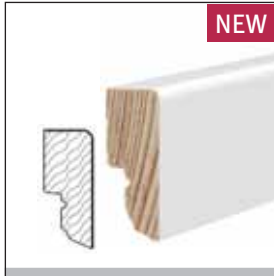
		
<p>Skirtings solid wood core veneered strong, matt look, 16x40 mm (cube)</p> <p>Length: 250 cm</p>	<p>Skirtings solid wood core veneered strong, matt look, 16x58 mm (cube)</p> <p>Length: 270 cm</p>	<p>Skirtings solid wood core veneered strong, matt look, 16x58 mm (cube) with insulation strips</p> <p>Length: 270 cm</p>

PU: 1 piece
Minimum quantity for discount: 10 piece
Packaging: 10 pcs./bundle packaged in film

Prices €/lm

	ID N°			ID N°			ID N°		
white laminate cover, strong ¹	410 638			409 837			410 639		

¹ Paintable (e.g. to match the wall paint)

Skirtings white for Laminate Floor – with recess for clips

PU: 1 piece
 Mini. quan. for discount: 10 piece
 Packaging: 10 pcs./bundle packaged in film

Prices €/lm



	ID N°			ID N°			ID N°			ID N°		
White ¹	409 775			406 857			409 833			407 430		
white laminate cover, textured				409 779								

¹ Paintable (e.g. to match the wall paint)

Skirtings white, PS foam waterproof – with recess for clips

PU: 1 piece
 Minimum quantity for discount: 10 piece
 Packaging: 10 pcs./bundle packaged in film

Prices €/lm



	ID N°			ID N°		
White	409 780			410 641		

Flexible foam skirting White

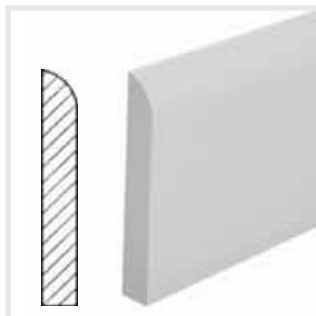

Flexible foam skirting, 10x69 mm

product line order
 delivery time approx. 1 week
 Packaging: 1 pc. per carton

Length: 240 cm

	ID N°	PU	Min. quant. f. discount		
White ¹	409 782	1 pc.			

¹ Paintable (e.g. to match the wall paint)

Antique skirtings – with recess for clips

PU: 1 piece
Minimum quantity for discount: 10 piece
Packaging: 10 pcs./
bundle packaged in film

Prices €/lm

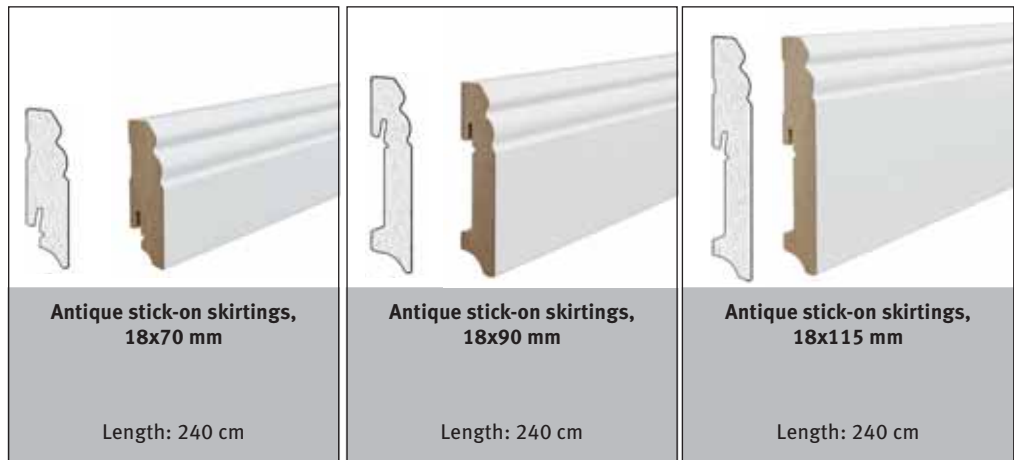

	ID N°			ID N°			ID N°		
MDF-coated white ¹	407 746			407 747			407 748		
MDF White finished	407 749			407 750			407 751		

¹ Paintable (e.g. to match the wall paint)

Accessories for Antique skirtings



Corner bars for Antique skirtings

- MDF core with white laminate cover
- Ideal for skirting corners and ends
- Simply cut to size and glue on

Contents 6 pc./pack
Dimensions 22x22x122 mm

ID N°	PU	Min. quant. f. discount		
407 853	1 pack	4 pack		

Quarter rounds

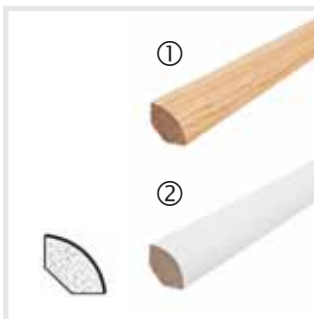

Quarter round (MDF) 14 x 14 mm

Packaging: 20 pcs. shrink-wrapped

Length: 240 cm

	ID N°	PU	Min. quant. f. discount		
Oak, veneered, prefinished matt (MDF)	409 369	1 pc.	20 pc.		
White lam. cover (MDF) ¹	409 368	1 pc.	20 pc.		

¹ Paintable (e.g. to match the wall paint)

Skirting Accessories



Clips for stick-on skirtings

Plastic skirting clips for the simple and invisible mounting of stick-on skirtings. The pack also includes the screws and plugs for fastening the clips to the wall.

Now including drilling template!

1 pack = 30 clips, screws, plugs and drilling template – enough for 15 metres

ID N°	PU	Min. quant. f. discount		
407 198	1 pack	10 pack		



NEW

HARO Nail clip

For easy and invisible installation of skirtings in all forms and materials.

With the HARO Nail clip, it is possible to move the skirting without any problems at a later time.

1 pack = 30 clips and plugs
Coverage: approx. 9 - 15 metres



ID N°	PU	Min. quant. f. discount		
410 634	1 pack	10 pack		



NEW

Seal lip rail

Rail system with integrated sealing lip suitable for all stick-on skirtings 19x58 mm. The HARO seal lip rail protects the expansion joint from moisture and the strip from moisture from below.

Length: 240 mm

ID N°	PU	Min. quant. f. discount		
410 635	1 pc.	20 pc.		

LED Skirting



A successful combination of fixing rail and LED strip. Each HARO skirting (with recess for clips) can be attached up to a height of 90 cm. This makes the system incredibly flexible.

LED strips

White light, self-adhesive
incl. transformer and dimmer with remote control
12 V/ 4.8 W/metre

Length: 500 cm

ID N°	PU	Min. quant. f. discount		
409 777	1 pc. = 5 m	–		



LED mounting rail Click-Fix silver

Mounting rail with channel for glueing on LED strips up to a height of 10mm.
Including matt and transparent PET channel cover.

Length: 240 cm

ID N°	PU	Min. quant. f. discount		
409 778	1 pc. = 2,4 m	–		



LED header, white

Header for LED fixing rail

Content: 2 pc./pack

ID N°	PU	Min. quant. f. discount		
410 378	1 pack	–		



Plastic corners

Plastic corner pieces in wood style for stick on skirting 19 x 58 mm

The corners make installation easier, as the mitre cut is no longer necessary. The headers and connectors also allow the skirtings to be covered at seams. Inhalt: 2 pieces per pack; with headers, a left and a right one.

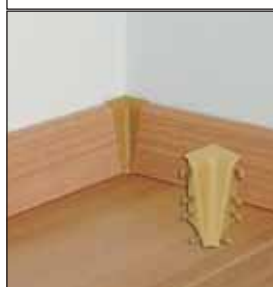

Inner corners



Outer corners



Connectors



Headers

Min. quantity f. discount
10 pack
PU 1 pack
Prices €/pack

	ID N°			ID N°			ID N°			ID N°		
Maple	407 113			407 127			407 141			407 155		
Apple *				407 133			407 147			407 161		
Pear Golden *	407 121			407 135			407 149			407 163		
Beech	407 112			407 126			407 140			407 154		
Oak	407 111			407 125			407 139			407 153		
Oak Dark	409 280			409 281			409 282			409 283		
Cherry/Walnut light *				407 131			407 145					
Merbau/Jatoba *	407 115			407 129			407 143			407 157		
Nordic Pine *							407 150					
Walnut dark	407 118			407 132			407 146			407 160		
Snow Pine *				407 712			407 713					
White	409 240			409 241			409 242			409 243		
Grey	409 276			409 277			409 278			409 279		
Gold	407 123			407 137			407 151			407 165		
Silver	407 124			407 138			407 152			407 166		

* While stocks last

Plastic corners

Plastic corner pieces in wood style for skirting 19 x 39S mm

The corners make installation easier, as the mitre cut is no longer necessary. The headers and connectors also allow the skirtings to be covered at seams. Inhalt: 2 pieces per pack; with headers, a left and a right one.

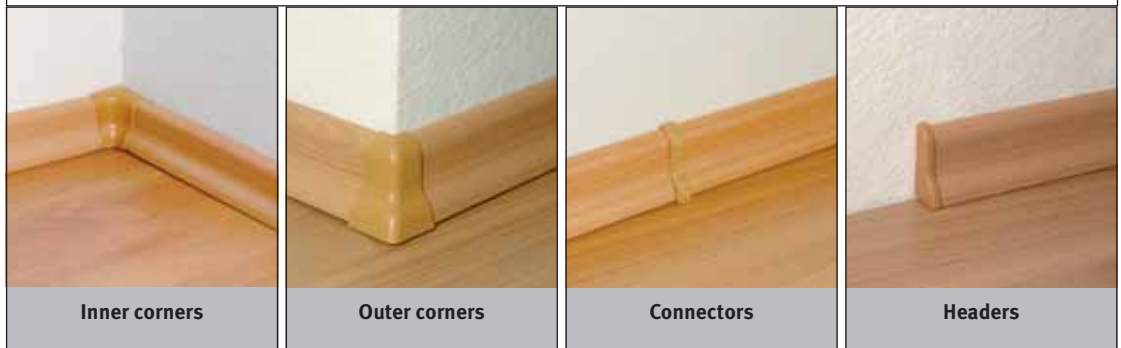

Min. quantity f. discount
10 pack
PU 1 pack
Prices €/pack

	ID N°			ID N°			ID N°			ID N°		
Maple *	408 704			408 714			408 723			408 733		
Apple *	408 707			408 717			408 726			408 736		
Pear Golden *	408 708			408 718			408 727			408 737		
Beech *	408 703			408 713			408 722			408 732		
Oak *				408 712			408 721			408 730		
Walnut dark *	408 706			408 716			408 725			408 735		
Snow Pine *	408 705			408 715			408 724			408 734		
Gold *	408 709			408 719			408 728			408 738		
Silver *	408 710			408 720			408 729			408 739		

* While stocks last

Plastic corner pieces in wood style for stick on skirting 19 x 39 mm

The corners make installation easier, as the mitre cut is no longer necessary. The headers and connectors also allow the skirtings to be covered at seams. Inhalt: 2 pieces per pack; with headers, a left and a right one.

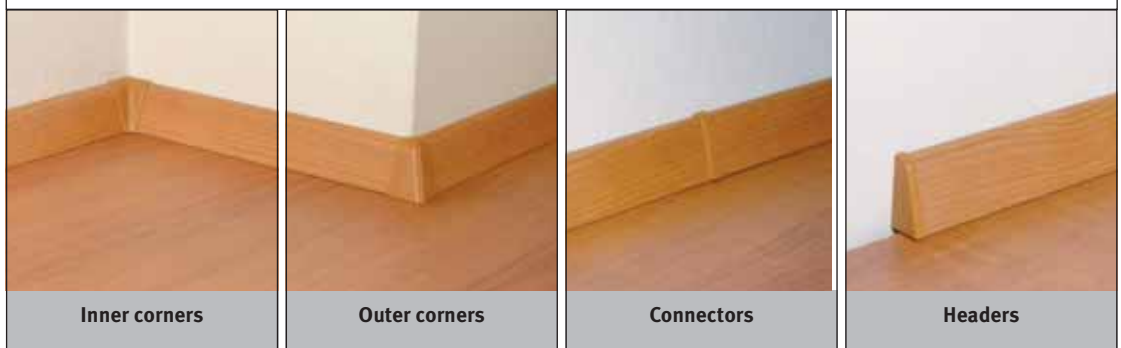

Min. quantity f. discount
10 pack
PU 1 pack
Prices €/pack

	ID N°			ID N°	€ excl.		ID N°			ID N°		
Maple *	407 056			407 071			407 085			407 099		
Apple *	407 063			407 077			407 091			407 105		
Pear Golden *	407 065			407 079			407 093			407 107		
Beech *	407 055			407 070			407 084			407 098		
Oak *				407 069			407 083			407 097		
Cherry/Walnut Light*	407 060			407 075			407 089			407 103		
Nordic Pine*	407 066			407 080			407 094			407 108		
Walnut Dark*	407 061						407 090			407 104		
Gold *	407 067			407 081			407 095			407 109		
Silver *							407 096			407 110		

* While stocks last



Mouldings

A floor cannot always be installed seamlessly throughout the entire home. Crossover points are especially unavoidable when you choose floating installation. Moulding systems provide the help you require, by bridging the necessary separating joints in the floor covering and providing stylish accents.

With the following overview, we would like to offer our advice to help you find the suitable moulding solution for your floor. If you have special requirements, we will gladly help you on request to determine the optimal floor moulding.

Explanation of the three most common types of mouldings, using the example of the Allround floor mouldings

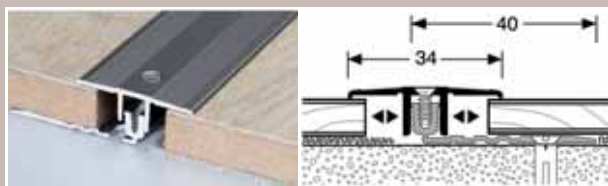

Transition moulding (or expansion joint moulding)

- For coverings that are equally high or with a variance of up to ± 5 mm

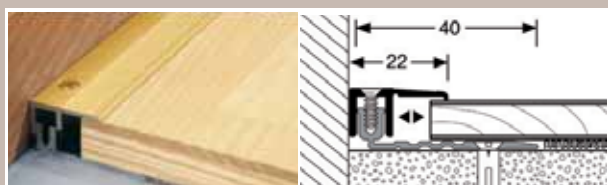

End moulding

- for perfect endings, boundaries of all coverings against higher, adjacent thresholds, tiles, patio doors and windows or other elevations



Reducer moulding (or levelling moulding)

- for coverings to adjacent, lower surfaces such as carpet, design floor, tiles etc.

Two-piece mouldings each consist of a base moulding, which is fixed in the floor (screwed or glued), and the top moulding, which is inserted from above onto the base moulding and also either screwed or clipped on to it, depending on the system.

All metal floor mouldings with holes are delivered incl. screws and dowels. ECO floor mouldings with Phillips screws, all other floor mouldings with Torx screws.

Overview

<i>For parquet floors</i>	<i>For Laminate and Design Floors from 7 mm</i>	<i>For design floors of up to 9.5 mm</i>	<i>Flexible height compensation with flex joint</i>	<i>Easy installation due to wide base moulding</i>	<i>Screw-mounted</i>	<i>For clips</i>	<i>For glue-down installation</i>	<i>Self adhesive</i>	<i>Rail raise through lift-up block</i>
---------------------------	---	--	---	--	----------------------	------------------	-----------------------------------	----------------------	---

Multi-part mouldings										
PREMIUM MOULDINGS XXL	for floor height 7 – 18 mm	•	•	•		•	•		•	•
PREMIUM MOULDINGS Flex	for floor height 7 – 17 mm	•	•	•	•	•	•		•	•
ALLROUND MOULDINGS	for floor height 7 – 15 mm	•	•	•		•	•		•	•
ECO Mouldings	for floor height 7 – 15 mm	•	•	•			•		•	•
CHAMPION STAR Mouldings	for floor height 4 – 9,5 mm			•		•	•		•	
EURO-CLIP Mouldings	Parquet 10 – 16 mm Laminate Floor 6 – 9,5 mm	•	•					•	•	
Euro Step Stair Nosings	for floor height 7 – 16 mm	•	•	•		•	•		•	•
One-piece mouldings										
Real wood mouldings		•								•
HDF Easy mouldings			•							•
Economy mouldings		•	•	•			•		•	•
Stair Nosings	for floor height 2,5 – 6,5 mm	•	•	•		•	•		•	

• Self-adhesive only with transition moulding

PREMIUM Mouldings for Parquet and Laminate

The versatile and flexible solution
for the highest demands.

NEW WITH A WIDE BASE SECTION

Transition Moulding Premium Flex Type 888

With flex function

“Articulated” three-piece transition moulding. Suitable for floor coverings from 7 to 17 mm thickness (with floor coverings of equal height). Also suitable for transitions of up to 12 mm, e.g. from 22 mm to 12 mm or from 13 mm to 3 mm. Anodised aluminium (screw-mounted).

Style	Length 90 cm			Length 100 cm			Length 270 cm		
	ID N°			ID N°			ID N°		
gold	405 219			407 168			405 222		
Silver	405 220			407 169			405 223		
Sand	405 221			407 170			405 224		
bronze	407 167			407 171			407 173		
stainless steel/titan	405 821			407 172			405 675		



Lift-up-block

Suitable for all Premium XXL, Premium Flex, Allround, ECO and Champion Star moulding systems. An additional height increase of 5 mm is achieved with each lift-up block.

Content per bag 6 pc./pack
Requirement
for 90 cm and 100 cm: 1 pack
Requirement for 270 cm: 3 pack

ID N°	PU	Min. quant. f. discount		
404 667	1 Pack	10 pack		

ALLROUND Mouldings for Parquet and Laminate

Proven products for safe application. Suitable for floor coverings between 7 and 15 mm. With a wide base section, for easy installation and even better fixation.

Transition moulding type 388 L/P
For a perfect transition between floor coverings of equal height (height differences of up to 5 mm can be evened out). For floor coverings from 7 to 15 mm thickness. Anodised aluminium. Screw-mounted and precisely adjustable.

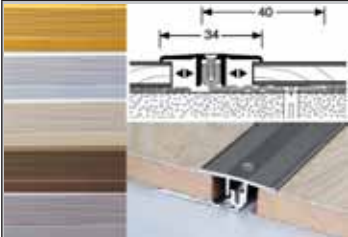
	Length 90 cm			Length 100 cm			Length 270 cm		
	PU: 1 pc. Min.quant. f. disc.: 10 pc. = 9 lm			PU: 1 pc. Min.quant. f. disc.: 10 pc. = 10 lm			PU: 1 pc. Min.quant. f. disc.: 10 pc. = 27 lm		
Style	ID N°			ID N°	€ excl. VAT		ID N°		
gold	404 494			404 528			404 509		
Silver	404 495			404 529			404 510		
Sand	404 497			404 643			404 512		
bronze	404 496			407 181			404 511		
stainless steel/titan	407 180			407 182			407 183		

End Moulding Type 387 L/P
For a neat finish of floor coverings, particularly at elevations (adjacent thresholds, tiles, flagstones, etc.). For floor coverings from 7 to 15 mm thickness. Anodised aluminium. Screw-mounted and precisely adjustable.

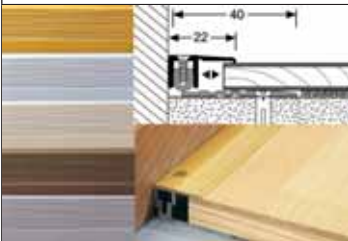
	Length 90 cm			Length 100 cm			Length 270 cm		
	PU: 1 pc. Min.quant. f. disc.: 10 pc. = 9 lm			PU: 1 pc. Min.quant. f. disc.: 10 pc. = 10 lm			PU: 1 pc. Min.quant. f. disc.: 10 pc. = 27 lm		
Style	ID N°			ID N°	€ excl. VAT		ID N°		
gold	404 499			404 526			404 514		
Silver	404 500			404 527			404 515		
Sand	404 502			404 644			404 517		
bronze	404 501			407 184			404 516		
stainless steel/titan	405 822			407 185			405 819		

Reducer Moulding Type 386 L/P
For a perfect transition from floor coverings to adjacent lower surfaces (carpeting, etc.). For floor coverings from 7 to 15 mm thickness. Anodised aluminium. Screw-mounted and precisely adjustable.

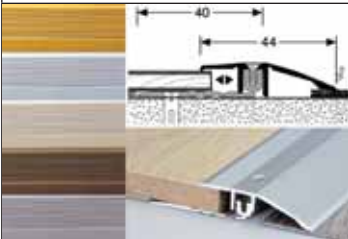
	Length 90 cm			Length 100 cm			Length 270 cm		
	PU: 1 pc. Min.quant. f. disc.: 10 pc. = 9 lm			PU: 1 pc. Min.quant. f. disc.: 10 pc. = 10 lm			PU: 1 pc. Min.quant. f. disc.: 10 pc. = 27 lm		
Style	ID N°			ID N°	€ excl. VAT		ID N°		
gold	404 504			404 524			404 519		
Silver	404 505			404 525			404 520		
Sand	404 507			404 645			404 522		
bronze	404 506			407 186			404 521		
stainless steel/titan	405 823			407 187			405 820		

ECO Mouldings for Parquet and Laminate

The entry-level range in the
floor mouldings range
Suitable for floor coverings between 7 and 15 mm.

Transition Moulding ECO Type 088

Two-piece entry-level moulding system, suitable for all floor coverings between 7 and 15 mm. Anodized aluminum. Can be screwed and precisely readjusted.

	Length 90 cm			Length 270 cm		
	PU: 1 pc. Min.quant. f. disc.: 10 pc. = 9 lm			PU: 1 pc. Min.quant. f. disc.: 10 pc. = 27 lm		
Style	ID N°			ID N°		
Silver	410 393			410 395		
Sand	410 394			410 396		

End moulding ECO Type 087

Two-piece entry-level moulding system, suitable for all floor coverings between 7 and 15 mm. Anodized aluminum. Can be screwed and precisely readjusted.

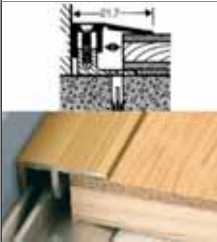
	Length 90 cm			Length 270 cm		
	PU: 1 pc. Min.quant. f. disc.: 10 pc. = 9 lm			PU: 1 pc. Min.quant. f. disc.: 10 pc. = 27 lm		
Style	ID N°			ID N°		
Silver	410 389			410 391		
Sand	410 390			410 392		

Reducer Moulding ECO Type 086

Two-piece entry-level moulding system, suitable for all floor coverings between 7 and 15 mm. Anodized aluminum. Can be screwed and precisely readjusted.

	Length 90 cm			Length 270 cm		
	PU: 1 pc. Min.quant. f. disc.: 10 pc. = 9 lm			PU: 1 pc. Min.quant. f. disc.: 10 pc. = 27 lm		
Style	ID N°			ID N°		
Silver	410 383			410 387		
Sand	410 386			410 388		

CHAMPION STAR – Mouldings

For design floors of up to 9.5 mm

For floor coverings between
4 and 9.5 mm thick.

NEW WITH A WIDE BASE SECTION

Champion Star 378 transition moulding

Two-piece, screw-on moulding system for design floors. For a perfect transition between floor coverings of equal height. Suitable for floor coverings from 4 to 9.5 mm thickness. Anodised aluminium. Screw-mounted and precisely adjustable.

	Length 100 cm			Length 270 cm		
	PU: 1 pc. Min.quant. f. disc.: 10 pc. = 10 lm			PU: 1 pc. Min.quant. f. disc.: 10 pc. = 27 lm		
Style	ID N°			ID N°		
Silver	409 683			409 686		
Sand	409 684			409 687		
stainless steel/titan	409 685			409 688		

Champion Star 377 end moulding

Two-piece, screw-on moulding system for design floors. Extra narrow moulding system for a neat finish. Suitable for floor coverings from 4 to 9.5 mm thickness. Anodised aluminium. Screw-mounted and precisely adjustable.

	Length 100 cm			Length 270 cm		
	PU: 1 pc. Min.quant. f. disc.: 10 pc. = 10 lm			PU: 1 pc. Min.quant. f. disc.: 10 pc. = 27 lm		
Style	ID N°			ID N°		
Silver	409 689			409 692		
Sand	409 690			409 693		
stainless steel/titan	409 691			409 694		

Champion Star 376 reducer moulding

Two-piece, screw-on moulding system for design floors. For a perfect transition from floor coverings to adjacent lower surfaces. Suitable for floor coverings from 4 to 9.5 mm thickness. Anodised aluminium. Screw-mounted and precisely adjustable.

	Length 100 cm			Length 270 cm		
	PU: 1 pc. Min.quant. f. disc.: 10 pc. = 10 lm			PU: 1 pc. Min.quant. f. disc.: 10 pc. = 27 lm		
Style	ID N°			ID N°		
Silver	409 695			409 698		
Sand	409 696			409 699		
stainless steel/titan	409 697			409 700		

HDF-Easy moulding for Laminate Floors



Transition moulding



Reducer moulding

HDF-Easy moulding

Transition or reducer moulding with simple and quick glue installation.

Matching colour and texture - material and colour are aligned.

When used as a transition moulding (different floor heights), a height compensation of 6 to 9 mm is possible between the two floor areas.

Length: 90 cm

PU: 1 pc.

Minimum quantity for discount:

10 pc. = 9 lm

Style	ID N°		
Afromosia/Iroko	409 907		
Alpine Oak Grey	409 908		
Alpine Oak Nature	409 517		
Vintage Oak	409 911		
Oak Antique Grey	409 514		
Oak Bergamo Antique Smoked	410 682		
Oak Bergamo Carbon	410 683		
Oak Bergamo Nature	410 684		
Oak Bergamo Silver Grey	410 685		
Oak Contura Smoked	410 686		
Oak Contura Black	409 913		
Oak Contura Stone Grey/Highland Oak	409 518		
Oak Sicilia White	409 916		
Oak Elegance	409 515		
Oak Emilia Grey	410 687		
Oak Emilia Honey	410 688		
Oak Emilia Puro	410 689		
Oak Emilia Velvet Brown	410 690		
Oak Emilia Velvet Grey	410 691		
Oak Emilia Velvet White	410 692		
Oak Emilia White	410 693		
Oak Italica Creme	409 918		
Oak Italica Smoked	409 919		
Oak Italica Nature	409 920		
Oak Liguria Greige	410 694		
Oak Portland Smoked/ Oak Veneto Honey	409 923		
Oak Portland Grey	409 924		
Oak Portland Nature	409 925		
Oak Portland Puro	409 926		
Oak Premium Creme	410 695		
Oak Sicilia Nature	410 433		
Oak Sicilia Puro	410 431		
Oak Veneto Crema	409 901		
Eiche Veneto Mocca	410 432		
Oak Veneto Sand	409 900		
Italian Walnut	409 935		
Chestnut Bianco	409 936		
Chestnut Impreso	409 937		
Scandinavian Oak	410 696		
StoneWood Creme	410 697		
Sycamore maple	409 943		

Real wood floor moulding for parquet



Real wood floor moulding for parquet

Transition or reducer moulding with simple and quick glue installation. Matching colour and texture. When used as a transition moulding (different floor heights), a height compensation to 9 mm is possible between the two floor areas.

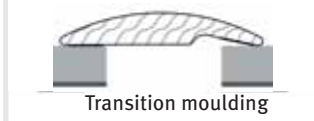

Transition moulding



Reducer moulding

Length: 90 cm

Wood species	ID N°	PU	Min. quant. f. discount		
Oak brushed, oiled	410 379	1 pc.	10 pc. = 9lm		

Product line orders for mouldings

The following mouldings are available on request within approx. 2 weeks delivery time. Many other versions are also possible and we will be happy to offer them on request.

For orders from this product range, a processing fee of €10 will be charged for order values which are lower than €100. Fast deliveries within 3-5 working days are possible on request.

PREMIUM Mouldings for Parquet and Laminate

The versatile and flexible solution for the highest demands.

Transition moulding Premium XXL Type 388

Product line orders

Designed for flooring thicknesses between 7 and 18 mm this system provides three major advantages: It can cover a 13% wider expansion joint of now up to 17.5 mm, allows using torx screws, and features reinforced countersunk holes for secure mounting.

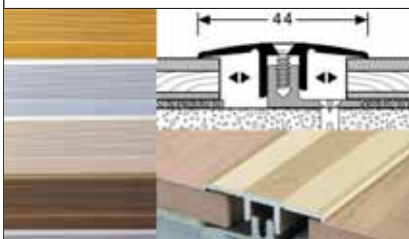

Style	Length 90 cm			Length 270 cm		
	ID N°			ID N°		
Gold, silver, sand, bronze, stainless steel/titan	406 276			406 276		

ECONOMY Mouldings

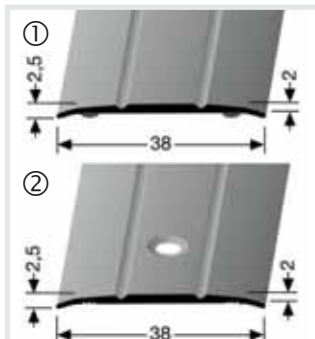

Transition moulding Type 438

Product line orders

Colour silver

Length: 270 mm

	ID N°	PU	Min. quant. f. discount		
Self-adhesive with protective sheeting ①	406 276	10 pc. = 27 lm	10 pc. = 27 lm		
with mounting holes ②	406 276	10 pc. = 27 lm	10 pc. = 27 lm		

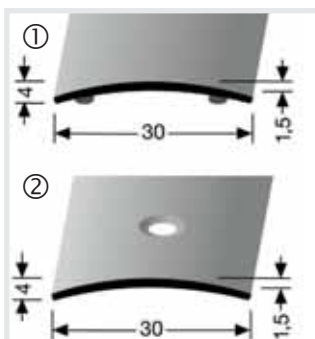

Transition moulding Type 459

Product line orders

Colour silver

Length: 270 mm

	ID N°	PU	Min. quant. f. discount		
Self-adhesive with protective sheeting ①	406 276	10 pc. = 27 lm	10 pc. = 27 lm		
with mounting holes ②	406 276	10 pc. = 27 lm	10 pc. = 27 lm		

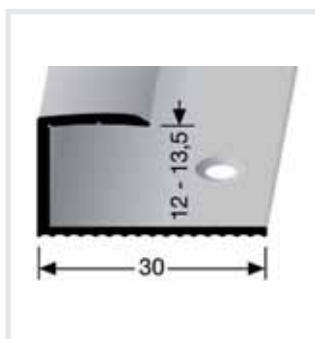

Joint moulding for Parquet Type 196

Product line orders

One-piece moulding for a smart and sleek ending of the floor covering especially at separating joints and doorways. Specially geared to HARO PARQUET 13.5 mm

Length: 270 cm

Colour	ID N°	PU	Min. quant. f. discount		
silver	406 276	20 pc. = 54 lm	20 pc. = 54 lm		

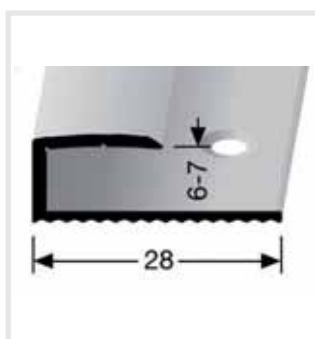

Joint moulding for Laminate Floors Type 192

Product line orders

One-piece moulding for a smart and sleek ending of the floor covering especially at separating joints and doorways. Specially geared to HARO Laminate Floor 7 mm

Length: 270 cm

Colour	ID N°	PU	Min. quant. f. discount		
silver	406 276	20 pc. = 54 lm	20 pc. = 54 lm		

EURO-CLIP - Mouldings for clips

For parquet floors

Euro-Clip transition moulding Type 588/588 E, available in different anodised or veneer colours

[Product line orders](#)

Two-piece clip-on moulding system for parquet floors. Featuring unique clip technology and a broad choice of high-quality covers, Euro-Clip is not only a very stylish, but also a very safe and easy moulding system for all parquet floors from 10 to 16 mm thickness.

	Length 90 cm			Length 100 cm			Length 270 cm		
	PU: 1 pc. Min.quant. f. disc.: 10 pc. = 9 lm			PU: 1 pc. Min.quant. f. disc.: 10 pc. = 10 lm			PU: 1 pc. Min.quant. f. disc.: 10 pc. = 27 lm		
Style	ID N°			ID N°			ID N°		
588: Anodised: Gold, silver, sand, bronze, stainless steel/titan, polished: Aluminium	406 276			406 276			406 276		
588 E: Real wood veneer: Beech dark, Beech light, Oak light, Maple, Merbau, Walnut, Cherry, Cork, Spruce	406 276			406 276			406 276		

Euro-Clip end moulding Type 587/587 E, available in different anodised or veneer colours

[Product line orders](#)

Two-piece clip-on moulding system for parquet floors. Featuring unique clip technology and a broad choice of high-quality covers, Euro-Clip® is not only a very stylish, but also a very safe and easy moulding system for all parquet floors from 10 to 16 mm thickness.

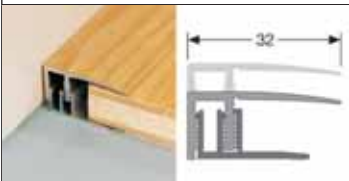
	Length 90 cm			Length 100 cm			Length 270 cm		
	PU: 1 pc. Min.quant. f. disc.: 10 pc. = 9 lm			PU: 1 pc. Min.quant. f. disc.: 10 pc. = 10 lm			PU: 1 pc. Min.quant. f. disc.: 10 pc. = 27 lm		
Style	ID N°			ID N°			ID N°		
587: Anodised: Gold, silver, sand, bronze, stainless steel/titan, polished: Aluminium	406 276			406 276			406 276		
587 E: Real wood veneer: Beech dark, Beech light, Oak light, Maple, Merbau, Walnut, Cherry, Cork, Spruce	406 276			406 276			406 276		

Euro-Clip reducer moulding Type 586/586 E, available in different anodised or veneer colours

[Product line orders](#)

Two-piece clip-on moulding system for parquet floors. Featuring unique clip technology and a broad choice of high-quality covers, Euro-Clip® is not only a very stylish, but also a very safe and easy moulding system for all parquet floors from 10 to 16 mm thickness.

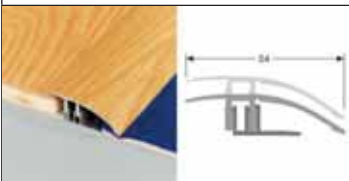
	Length 90 cm			Length 100 cm			Length 270 cm		
	PU: 1 pc. Min.quant. f. disc.: 10 pc. = 9 lm			PU: 1 pc. Min.quant. f. disc.: 10 pc. = 10 lm			PU: 1 pc. Min.quant. f. disc.: 10 pc. = 27 lm		
Style	ID N°			ID N°			ID N°		
586: Anodised: Gold, silver, sand, bronze, stainless steel/titan, polished: Aluminium	406 276			406 276			406 276		
586 E: Real wood veneer: Beech dark, Beech light, Oak light, Maple, Merbau, Walnut, Cherry, Cork, Spruce	406 276			406 276			406 276		

EURO-CLIP - Mouldings for clips

For Laminate and Design Floors from 6,5 mm

Euro-Clip transition moulding Type 588 L/588 LH, available in different anodised or laminate colours

[Product line orders](#)

Two-piece clip-on moulding system for laminate floors. Featuring unique clip technology and a broad choice of high-quality covers, Euro-Clip is not only a very stylish, but also a very safe and easy moulding system for all laminate floors from 6 to 9.5 mm thickness.

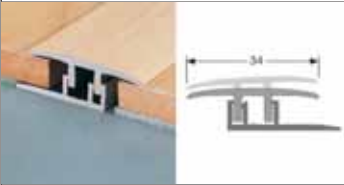
	Length 90 cm			Length 100 cm			Length 270 cm		
	PU: 1 pc. Min.quant. f. disc.: 10 pc. = 9 lm			PU: 1 pc. Min.quant. f. disc.: 10 pc. = 10 lm			PU: 1 pc. Min.quant. f. disc.: 10 pc. = 27 lm		
Style	ID N°			ID N°			ID N°		
588 L: Anodised: Gold, silver, sand, bronze, stainless steel/titan, polished: Aluminium	406 276			406 276			406 276		
588 LH: Wood reproduction: Beech Dark, Beech Light, Oak Light, Oak Dark, Maple, Merbau, Walnut, Oak White Limewashed, Wenge	406 276			406 276			406 276		

Euro-Clip transition moulding Type 587 L/587 LH, available in different anodised or laminate colours

[Product line orders](#)

Two-piece clip-on moulding system for laminate floors. Featuring unique clip technology and a broad choice of high-quality covers, Euro-Clip is not only a very stylish, but also a very safe and easy moulding system for all laminate floors from 6 to 9.5 mm thickness.

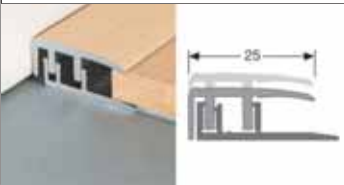
	Length 90 cm			Length 100 cm			Length 270 cm		
	PU: 1 pc. Min.quant. f. disc.: 10 pc. = 9 lm			PU: 1 pc. Min.quant. f. disc.: 10 pc. = 10 lm			PU: 1 pc. Min.quant. f. disc.: 10 pc. = 27 lm		
Style	ID N°			ID N°			ID N°		
587 L: Anodised: Gold, Silver, Sand, Bronze, Stainless Steel/Titan, polished: Aluminium	406 276			406 276			406 276		
587 LH: Wood reproduction: Beech Dark, Beech Light, Oak Light, Oak Dark, Maple, Merbau, Walnut, Oak White Limewashed, Wenge	406 276			406 276			406 276		

Euro-Clip® reducer moulding Type 586 L/586 LH, available in different anodised or laminate colours

[Product line orders](#)

Two-piece clip-on moulding system for laminate floors. Featuring unique clip technology and a broad choice of high-quality covers, Euro-Clip is not only a very stylish, but also a very safe and easy moulding system for all laminate floors from 6 to 9.5 mm thickness.

	Length 90 cm			Length 100 cm			Length 270 cm		
	PU: 1 pc. Min.quant. f. disc.: 10 pc. = 9 lm			PU: 1 pc. Min.quant. f. disc.: 10 pc. = 10 lm			PU: 1 pc. Min.quant. f. disc.: 10 pc. = 27 lm		
Style	ID N°			ID N°			ID N°		
586 L: Anodised: Gold, silver, sand, bronze, stainless steel/titan, polished: Aluminium	406 276			406 276			406 276		
586 LH: Wood reproduction: Beech Dark, Beech Light, Oak Light, Oak Dark, Maple, Merbau, Walnut, Oak White Limewashed, Wenge	406 276			406 276			406 276		

Radiator rosettes

Radiator Rosettes
 Made of premium solid wood presenting a pleasant, harmonious overall appearance. Thanks to their low height, they elegantly and unobtrusively blend into the room. The radiator rosettes match the most popular wood species.

	Inside diameter 15 mm Outside diameter 5 cm			Inside diameter 19 mm Outside diameter 5 cm			Inside diameter 22 mm Outside diameter 5 cm		
	PU: 1 pc. Min. quant. for discount: 10 pc.			PU: 1 pc. Min. quant. for discount: 10 pc.			PU: 1 pc. Min. quant. for discount: 10 pc.		
Wood species	ID N°			ID N°			ID N°		
Oak	403 575			403 449			403 448		
Beech	403 574			403 453			403 452		
Maple	403 576			403 442			403 441		
Cherry*				403 444					
darker wood types	406 210			406 211			406 212		
White	409 244			409 245			409 246		

Double Radiator Rosettes
 Made of premium solid wood presenting a pleasant, harmonious overall appearance. The elegant solution for double radiator pipes. Inside diameter: 19 mm
 Dimensions: 11x58x122 mm

Wood species	ID N°	PU	Min. quant. f. discount		
Oak	405 162	1 pc.	10 pc.		
Beech	405 163	1 pc.	10 pc.		
Maple	405 164	1 pc.	10 pc.		
White	409 247	1 pc.	10 pc.		

Double Radiator Rosettes
 For individual holes Dimensions: 12x50x120 mm

Wood species	ID N°	PU	Min. quant. f. discount		
Oak	405 530	1 pc.	10 pc.		
Beech	405 531	1 pc.	10 pc.		
Maple	405 532	1 pc.	10 pc.		
White	409 249	1 pc.	10 pc.		



Quick, easy and natural maintenance of all floors

The revolution in natural floor care.

Clean & Green, the floor care line for quick, easy, effective and ecological cleaning and maintenance. Our decades of experience with the different floor types have gone into the development of the Clean & Green products.



1



2

www.blauer-engel.de/uz12a

Parquet cleaner natural

for all types of natural floors

Intensive cleaner active

for Laminate Floor and DISANO design floor and for deep cleaning of Parquet

Floor Care aqua shield

for prefinished parquet floors and coated surfaces

Parquet care aqua oil

Initial treatment and subsequent maintenance of oiled surfaces

All surfaces cleaned and maintained with only two products.

The beauty treatment for prefinished and coated surfaces.

The beauty treatment for oiled parquet floors.

For regular cleaning and care of all parquet surfaces, cork floors, linoleum floors, CELENIO wood tiles and open-pored stone floors of terracotta, slate, granite or marble.

For regular cleaning of laminate floors, DISANO design floors, synthetic/PVC, rubber, glazed and unglazed tiles, porcelain stoneware tiles and for deep cleaning of parquet and other natural floors.

For refurbishing pre-finished parquet floors and coated floor coverings, such as laminate floor. Apply with the „Wischwiesel“ flat wet-mop after the basic cleaning. With clean & green aqua shield the floor shows its full beauty again.

clean & green aqua oil has the tremendous advantage that you need no polishing machine, which used to be required before. Maintaining oiled parquet floors is now easier, quicker and, above all, much cheaper with the new aqua oil. Linseed oil has been one of the best wood protection and maintenance products for centuries. clean & green aqua oil is based on linseed oil and gives you an environmentally friendly, yet effective way to optimally care for your floor. Every oiled natural floor will now show off its beauty for a long time.

Additionally, the durability is improved and the floor is protected from moisture penetrating from above.

	Intensive cleaner active	Parquet cleaner natural	Floor Care aqua shield	Parquet care product aqua oil
Laminate Floor	Regular cleaning		Visual refurbishing ³	
Synthetic/PVC floors	Regular cleaning		Visual refurbishing ³	
Vinyl floors	Regular cleaning		Visual refurbishing ³	
Glazed/unglazed tiles	Regular cleaning			
Porcelain stoneware	Regular cleaning			
DISANO design floors	Deep cleaning	Regular cleaning	Visual refurbishing ³	
Parquet floors (varnished)	Deep cleaning	Regular cleaning	Visual refurbishing ³	
Cork floors (varnished)	Deep cleaning	Regular cleaning	Visual refurbishing ³	
Linoleum Floor	Deep cleaning	Regular cleaning		
CELENIO wood floors	Deep cleaning	Regular cleaning	Visual refurbishing ³	
Open-pored stone floors	Deep cleaning	Regular cleaning		
Parquet floors (oiled)	Deep cleaning	Regular cleaning		Intensive care ³
Parquet Floor (naturaDur)	Deep cleaning	Regular cleaning	Visual refurbishing ³	
Parquet Floor (HARO Spa)	Deep cleaning	Regular cleaning		First treatment and intensive care
Cork floors (oiled)	Deep cleaning	Regular cleaning		Intensive care ³

1) EU eco label for clean & green natural, active und aqua oil
 2) Blue angel for aqua shield.
 3) Changes in the gloss level may occur.



clean & green natural parquet cleaner

Eco floor care concentrate for regular cleaning of:

- All parquet surfaces
- Cork floors
- Linoleum floors
- CELENIO
- DISANO design floors

- Open-pored stone floors (terracotta, slate, granite, marble)

Contents 500 ml
Coverage: approx. 40 applications

ID N°	PU	Min. quant. f. discount		
407 716	1 can	12 can		



clean & green active intensive cleaner

Eco floor cleaner concentrate for regular cleaning of:

- Laminate floors
- Synthetic/PVC, rubber
- Glazed or unglazed tiles
- Porcelain stoneware tiles

And for deep cleaning of:

- Parquet
- DISANO design floors
- Other natural floors

Contents 500 ml
Coverage: approx. 40 applications

ID N°	PU	Min. quant. f. discount		
407 717	71 can	12 can		



clean & green aqua oil parquet care

Floor care for oiled surfaces (Parquet, Cork Floors and HARO Spa Parquet)

- no polishing machine required.

Content: 1000 ml
Coverage: approx. 20 ml/m²
1 l ≈ 50 m² (depending on the wood type)

ID N°	PU	Min. quant. f. discount		
409 472	41 pc.	6 can		



clean & green aqua oil white parquet care

Special care product for oiled white surfaces. For refreshing the surface finish of white oiled parquet exposed to wear and tear, and for touching up scratches.

Contents 1000 ml
Coverage 20 ml/m²
1 l ≈ 50 m² (depending on the wood type)

ID N°	PU	Min. quant. f. discount		
409 474	1 can	6 can		



clean & green aqua oil black parquet care

Care for oiled black surfaces. For refreshing the surface finish of black oiled parquet exposed to wear and tear, and for touching up scratches.

Contents 1000 ml
Coverage 20 ml/m²
1 l ≈ 50 m² (depending on the wood type)

ID N°	PU	Min. quant. f. discount		
409 473	1 can	6 can		



clean & green floor care aqua shield

Durable refurbishing and protection of prefinished and coated surfaces

- no polishing machine required.

Contents 1000 ml
Coverage: approx. 30 ml/m²
1 l ≈ 35 m² (depending on the surface finish)

ID N°	PU	Min. quant. f. discount		
409 774	1 can	6 can		

Floor care tools



clean & green 'Wischwiesel' for aqua oil and aqua shield

Ideal for applying the aqua oil and aqua shield parquet care products.
Ensures easy, even and streak-free application!
Mop width 40 cm .

With 3-piece telescopic handle:
3x50 cm

ID N°	PU	Min. quant. f. discount		
407 639	1 pc.	-		



clean & green Cover for 'Wischwiesel'

Washable mop head for 'Wischwiesel' flat wet-mop – made of microfibre.
Width: 40 cm

ID N°	PU	Min. quant. f. discount		
407 640	1 pc.	-		



clean & green mop head for 'Wischwiesel' flat wet-mop, specially designed for heavy brushed parquet

Washable mop head for 'Wischwiesel' flat wet-mop - made of microfibre.
Width: 40 cm

ID N°	PU	Min. quant. f. discount		
408 932	1 pc.	-		



clean & green bucket

Sturdy bucket for 'Wischwiesel' flat wet-mop. 20 litre capacity.

ID N°	PU	Min. quant. f. discount		
408 209	1 pc.	-		



Floor cleaner set

For the application of clean & green active and natural.
Width: 40 cm

ID N°	PU	Min. quant. f. discount		
407 448	1 pc.	-		



Cotton cover for floor cleaner set

Width: 40 cm

ID N°	PU	Min. quant. f. discount		
407 449	1 pc.	-		

Floor care tools



Polishing Cloth

Special cloth for cleaning and care; also excellent for buffing and drying.

Content: 10 pc./bag

ID N°	PU	Min. quant. f. discount		
403 139	1 bag	50 bag		

Floor care products for bioTec oil/wax finish



Oil Balm

Specially formulated floor care product for repair work and for the intensive care of oil/wax-finished parquet in demanding applications. Also suitable for the surface treatment of sanded, unfinished parquet.

Content: 750 ml
Coverage: approx. 7 ml/m²

ID N°	PU	Min. quant. f. discount		
403 129	1 can	4 can		



Oil balm, white

Specially formulated floor care product for repair work and for the intensive care of white-pigmented oil/wax-finished parquet in demanding applications. Also suitable for the surface treatment of sanded, unfinished parquet.

Content: 750 ml
Coverage: approx. 7 ml/m²

ID N°	PU	Min. quant. f. discount		
403 622	1 can	4 can		



Fibre pad, white

For the care of oil/wax-finished HARO PARQUET together with Oil Balm.

150x230 mm
Content/carton 5 pc.

ID N°	PU	Min. quant. f. discount		
403 602	1 pack	10 pack		

Floor care products for naturaLin natural oil finish



Floor Care Set Natural Floor Oil

Used for initial treatment and intensive care of parquet with naturaLin plus natural oil finish. The oil penetrates into the wood pores and ensures deep impregnation, while giving the wood surface a unique natural appearance.

Bulk containers available on request!

Contents 1000 ml
Coverage: approx. 200 m²

ID N°	PU	Min. quant. f. discount		
410 421	1 can	6 can		



Spraybottle

For spraying on naturaLin Oil

Content: 1000 ml

ID N°	PU	Min. quant. f. discount		
405 903	1 pc.	–		



naturaLin Soap

Soap cleaner based on soya/coconut oil for regular cleaning and care of parquet flooring with naturaLin plus natural oil finish.

Content: 1000 ml

ID N°	PU	Min. quant. f. discount		
410 422	1 can	6 can		

Floor care accessories

Our care accessories help protect and keep your HARO floor looking good for a long time.



Protective floor mat

Polycarbonate is unbreakable according to ISO 179. Produced without softeners and solvents; non-odorous and 100% recyclable. Suitable for use over underfloor heating.

size L 150x120 cm
size M 90x120 cm
Thickness 2 mm

Size	ID N°	PU	Min. quant. f. discount		
size L	402 403	1 pc.	10 pc.		
size M	405 529	1 pc.	10 pc.		



Protective felt pads, screw-on

Diameter 24 mm
Content per bag 8 pc. (for 2 chairs)

ID N°	PU	Min. quant. f. discount		
400 009	1 bag	10 bag		

Floor care accessories



Chair leg pads made of Teflon (PTFE) – self-adhesive, round

High-quality chair leg pads made of Teflon with excellent gliding properties and minimum friction. Self-adhesive, round.

Content/carton 8 pc. (for 2 chairs)

Size	ID N°	PU	Min. quant. f. discount		
22 mm	408 211	1 Pack	10 pack		
25 mm	408 278	1 Pack	10 pack		
30 mm	408 279	1 Pack	10 pack		



Chair leg pads made of Teflon (PTFE) – self-adhesive, square

High-quality chair leg pads made of Teflon with excellent gliding properties and minimum friction. Self-adhesive, square.

Content/carton 8 pc. (for 2 chairs)

Size	ID N°	PU	Min. quant. f. discount		
25 x 25 mm	408 281	1 Pack	10 pack		
30 x 30 mm	408 282	1 Pack	10 pack		



Chair leg pads made of Teflon (PTFE) – round, screw-on

High-quality chair leg pads made of Teflon with excellent gliding properties and minimum friction. Round, screw-on.

Content/carton 8 pc. (for 2 chairs)

Size	ID N°	PU	Min. quant. f. discount		
22 mm	408 210	1 Pack	10 pack		
25 mm	408 277	1 Pack	10 pack		
30 mm	408 280	1 Pack	10 pack		



Fidbox V.6

Installed underneath the parquet floor, the Fidbox device regularly measures and stores temperature and air humidity.

The results can be read any time via bluetooth and without touching the floor. Reading the saved data is possible by means of the fidbox V.6 USB reader and the corresponding app.

Model	ID N°	PU	Min. quant. f. discount	€ excl. VAT	
Fidbox V.6 ①	409 642	–			
USB reader ②	409 643	–	–		

Renovation

Professional help for enduring enjoyment of your floor

Wherever damage should occur, you can easily improve the damage with our renovation products.

Service Box

This complete kit is the professional solution for remedying surface blemishes of our floor coverings. Supplied in a functional, easy-to-transport case. Refills can be ordered separately for all items.



HAMBERGER Service Box - the complete kit for renovations

For professionals

Content: Entire range with soft wax C12, hard wax C13, C22 paint pen, spare tips for paint pen, clear lacquer brush pen C28, filling planer C46, varnish scraper, sanding mat, cleaning and degreasing mat, Trikot DIN A5, HARO special repair putty, varnish, spatula, sanding paper. Available with hard wax melter C41 or battery-operated hard wax melter.

Model	ID N°	PU		
with hard wax melter C41	402 168	1 pc.		
with battery-operated hard wax melter	405 972	1 pc.		



HARO Repair Kit

For DIYers

Repair kit with hard wax C13 for quick and professional repair of dents and scratches in HARO floor coverings and other wood or synthetic surfaces

Content: Battery-operated professional hard wax melter C48 (3 batteries included), filler plane C46, grey pad, white/green pad, Clear Lacquer Brush Pen C28, hard wax C1, cotton cloth

ID N°	PU	Min. quant. f. discount		
409 416	1 pc.	-		



Battery-operated hard wax melter

For DIYers

Handy, easy-to-use hard wax melter for mending small damaged spots.

ID N°	PU	Min. quant. f. discount		
405 864	1 pc.	10 pc.		



Hard wax melter C41

For professionals

For the professional application of hard wax C13.

ID N°	PU	Min. quant. f. discount		
400 474	1 pc.	-		



Hard wax set

For DIYers

For the professional repair of minor damage to the wood surface (e.g. dents, scratches, etc.)
For the hard wax melter. Each pack contains 4 bars of 4 cm length.

Colour	ID N°	PU	Min. quant. f. discount	€ excl. VAT	
Lighter wood types	405 865	1 Pack	5 pack	€ 12,46/pack	
middle, red wood types	405 867	1 Pack	5 pack	€ 12,46/pack	
darker wood types	405 866	1 Pack	5 pack	€ 12,46/pack	



Hard wax C13

For professionals

For the professional repair of minor damage to the wood surface (e.g. dents, scratches, etc.)
Available in different wood colours which can be intermixed, as desired. In this way, the colour and tone even of fine wood textures can be reproduced.

Content per assortment: Each pack contains 5 bars of different colours.

Colour	ID N°	PU	Min. quant. f. discount	€ excl. VAT	
lighter wood types	400 364	1 Pack	5 pack	€ 16,25/pack	
Oak colours	400 366	1 Pack	5 pack	€ 16,25/pack	
red wood types	400 368	1 Pack	5 pack	€ 16,25/pack	
grey colours, white	402 058	1 Pack	5 pack	€ 16,25/pack	
Beech colours	409 671	1 Pack	5 pack	€ 16,25/pack	



Scraper

For professionals

To scrape off the hard wax until it is level with the surrounding flooring.

ID N°	PU	Min. quant. f. discount		
400 470	1 pc.	-		



Soft wax C12 with spatula

For DIYers

The filling material for quickly repairing small damage, such as cracks and chipping.

Each pack of 2 comes with a spatula.

Colour	ID N°	PU	Min. quant. f. discount		
Maple/Beech light/Birch/Ash	405 576	1 pc.	10 pc.		
Larch/Spruce/Pine	405 577	1 pc.	10 pc.		
Beech steamed/Cherry	405 578	1 pc.	10 pc.		
Oak/Red oak/Smoked oak/Iroko	405 579	1 pc.	10 pc.		
Merbau / Jatoba	405 580	1 pc.	10 pc.		
Walnut/African oak/Wenge	405 581	1 pc.	10 pc.		
White RAL 9010	405 582	1 pc.	10 pc.		



HARO repair putty set

For repairing larger or wider damaged spots on the wood surface, e.g. dents, nicks, splinters, etc.

Complete with repair putty, varnish, spatula and sanding paper.

The product is not subject to labelling regulations pursuant to the German Hazardous Substances Ordinance (GefStoffV).

For DIYers

For professionals

Colour	ID N°	PU	Min. quant. f. discount		
Beech Steamed	405 840	1 pc.	8 pc.		
Beech light/Maple	405 842	1 pc.	8 pc.		
Oak	405 841	1 pc.	8 pc.		
Smoked oak	405 844	1 pc.	8 pc.		
Cherry	405 846	1 pc.	8 pc.		
Merbau/Iroko	405 848	1 pc.	8 pc.		
African oak/Wenge	405 847	1 pc.	8 pc.		
white	405 845	1 pc.	8 pc.		



C22 paint pen.

The quick touch-up varnish in different wood tones for colouring blemishes with and across the grain, e.g. minor scratches.

For DIYers

For professionals

Colour	ID N°	PU	Min. quant. f. discount		
Beech	405 555	1 pc.	5 pc.		
Oak	405 556	1 pc.	5 pc.		
Maple	405 554	1 pc.	5 pc.		
Walnut	405 557	1 pc.	5 pc.		



Clear Lacquer Brush Pen fix C28

For the quick finishing of finest scratches and abrasions or a filled spot with soft or hard wax.

Targeted varnishing without spray mist.

For DIYers

For professionals

ID N°	PU	Min. quant. f. discount		
409 680	1 pc.	5 pc.		

	For DIYers Minor damage to the floor	For professionals Professional renovation
Hard wax set	●	●●●
Hard wax C13	●	●●●
Soft wax C12	●●	●
HARO repair putty set	●●●	●●●
C22 paint pen.	●●●	●●●
Battery-operated hard wax melter	●●●	●
Hard wax melter C41	●	●●●
Clear Lacquer Brush Pen fix C28	●●●	●●●

- excellently suited
- well suited
- suitable to only a limited extent

- For DIYers
- For professionals

General Terms and Conditions of Business of the Hamberger Flooring GmbH & Co. KG, D-83003 Rosenheim

1. General

All our legal relationships, including consultancy services performed within their scope, that are not the subject-matter of a separate consultancy agreement, shall be based on our "General Terms and Conditions of Business." In addition, all and any deliveries of wood effected within the Federal Republic of Germany shall be subject to the procedures used according to customary trade practice in the wood-processing industry, and in particular to the provisions of what is known as the "Tegernseer Gebrauche" in the latest version applicable at each respective time, including all its annexes and its appendix – to the extent that they are not contradictory to these General Terms and Conditions of Business. The wording of said provisions is understood to be known. Otherwise the text shall be sent upon request. Our General Terms and Conditions of Business shall be applicable to all and any legal transactions with contractors within the meaning of §14 of the German Civil Code [BGB]. We shall not recognise any terms or conditions of purchase on the part of any party contracting with us, or any agreements in deviation of our General Terms and Conditions of Business, unless their applicability is acknowledged in our order confirmation.

2. Offers – Conclusion of Contract – Prices

Our offers shall be subject to confirmation. A contract shall not be deemed to be concluded until the order is confirmed or executed by us. Our offers shall be subject to prior sale.

The specifications, drawings and illustrations, as well as descriptions relating to delivery and performance contained in our brochures, catalogues, price lists, or in the offer or documents pertaining to the offer, are approximate values in accordance with customary trade practice, unless in the order confirmation they have expressly been referred to as binding. We reserve the right to make changes in the manufacturing process and shape of the delivery item, to the extent that such changes are acceptable for the purchaser.

If an offer is made on a sample basis, the colour and texture of the sample shall not be deemed warranted qualities. Samples provided will only represent an average condition of the goods. Specifications as to dryness, weight, etc. will be given according to the best of our knowledge, but shall be without engagement.

Our prices are quoted ex works, free lorry or wagon, plus VAT. If flooring or panelling for walls or ceilings is installed by ourselves, our quotations shall comprise delivery free construction site. Prices quoted in our offers shall be binding on us for 30 calendar days.

In the event of an essential change of certain cost factors – wages, packing material, or freight – occurring between the conclusion of a transaction and delivery, the agreed price may be adjusted, within reasonable limits, according to the influence of the relevant cost factors, but by no more than a maximum of 5%. In the event of price increases, the purchaser shall have the right to declare his repudiation of the contract.

3. Credit-worthiness

When accepting orders, we shall assume that the contractor is solvent. If it turns out that this condition was not fulfilled, or noticeably is no longer fulfilled, we shall be entitled to revoke credit terms granted, claim cash in advance of further deliveries, demand payment or securities against return of all bills of exchange and cheques accepted by way of payment, or rescind the contract. This shall also apply if the contractor is in delay regarding the payment of earlier invoices, in the event of a returned debit note, protest of a cheque or bill of exchange, or if a substantial deterioration of his financial circumstances becomes known.

4. Delivery and Passing of Risk – Shipment and Packing

Delivery times shall not be deemed fixed dates unless expressly referred to as such.

Part shipments shall be admissible within reasonable limits and shall have to be accepted. In the event of delays in delivery or performance due to force majeure or as a result of occurrences making performance substantially difficult or impossible – these include particularly operational disturbances, strike, lockout, natural phenomena, government acts and disturbance of traffic routes –, we shall be released from the obligation to deliver or perform for the duration of such impediment plus a reasonable preparation time. The same shall apply in the event that supplies delivered to us are incorrect or do not arrive in due time, unless we are responsible for this. If so requested, our contractor shall have to declare whether he repudiates the contract as a result of the delay, or whether he insists on delivery. Any claims for damages, even on the grounds of delays going beyond the limits outlined above, shall be ruled out unless we are liable due to intent or gross negligence or on the grounds of injury to life, body, or health. This shall not involve any change in the burden of proof to the disadvantage of our contractors. If the delivery of orders placed on an on-call basis is not requested within one month after expiry of the agreed deadline, we shall be entitled to optionally either insist on immediate acceptance or immediately rescind the contract without fixing another deadline. The same shall apply in the case of orders to be performed on call with no particular deadline agreed for demanding delivery, if more than 4 months have elapsed without any request for delivery since the order was confirmed. Contractors shall not be entitled to assert any rights before granting us a reasonable final deadline of at least eight workdays

5. Warranty

Wood is a natural product. Its natural properties, variations and features are therefore to be taken into account in any case. In particular, the purchaser shall have to consider the biological, physical, and chemical properties when buying, processing and using wood. The natural range of variation in terms of colour,

texture, and other characteristics within one species of wood is typical of wood as a natural product and shall not represent any cause for complaint or liability claims. If need be, our contractor shall have to seek appropriate technical advice.

Only our product description shall be deemed agreed for the condition of goods. Public statements or extolling in advertisements shall not represent any additional indication as to the condition of goods under the contract.

Any complaints referring to immediately noticeable defects in terms of quality, inadequate installation, delivery of the wrong goods, and quantity variance shall have to be notified in writing without delay, at the latest within 8 days after receipt of the goods or performance of the work. Complaints shall have to be stated at any rate before processing or using the goods. Once the delivery or performance has been accepted, any subsequent objections shall be ruled out. If goods have been made available for collection and neither the contractor nor any other person authorised by the same appears to collect them, such goods shall be deemed accepted.

Defects that are not obvious, or defects occurring during or after processing or installation, shall have to be notified in writing without delay, at the latest within 10 workdays after being discovered. The burden of proof for the date of finding such defect shall be on the contractor.

In the case of bilateral mercantile transactions between merchants, §§ 377 & 378 of the German Commercial Code [HGB] shall remain unaffected. The purchaser shall have to inform us of any circumstances bringing warranty into operation in favour of a consumer, as soon as possible after learning about the case.

In the event of justified objections, we shall deliver any quantities missing and otherwise provide free remedy, grant a price reduction, replace or take back goods, whichever we may choose. To the extent that our products are also installed by us (e.g. flooring, panelling of ceilings and walls), the contractor shall assume the responsibility for adequate and safe intermediate storage of the products delivered.

If remedying or substitute delivery fails or becomes impossible, our contractor shall be entitled to cancel the contract – except if involving the performance of building work – or to reduce the purchase price, whichever he may choose to satisfy his claims.

We shall assume liability for the absence of warranted qualities only to the extent that such warranty shall serve the particular purpose of covering the contractor against the consequential damage resulting from the absence of such qualities. The mere reference to DIN or EN standards shall not make their contents a warranted quality.

Claims based on defects of quality shall become statute-barred in 12 months. This shall not apply in the event that the law prescribes longer periods of limitation pursuant to § 438, para. 1, item 2 (Buildings and Items for Buildings), § 479, para. 1 (Claim under a Right of Recourse), and § 634 a), para. 1, item 2 (Constructional Defects) of the German Civil Code [BGB].

Reciprocal claims for damages, no matter what the legal basis may be, in particular on the grounds of neglect of contractual obligations and damage claims in tort, shall be ruled out unless otherwise provided in the following. This shall also apply in particular to consequential damage and claims for compensation of expenses.

In the event that essential obligations under the contract should be neglected, liability shall be limited to such damage as is typical of the contract and is predictable. This shall not apply in cases where liability is mandatory, e.g. under the product liability statute, in cases of intent or gross negligence, or on the grounds of injury to life, body, or health.

If delivery or performance is impossible and we are responsible for this, the contractor's claim for damages shall be limited to a maximum of 10% of the value of that part of the delivery which cannot be put to appropriate use as a result of such impossibility. The right to cancel the contract shall remain unaffected.

6. Performance of Installation

If we undertake to perform installation work (flooring, panelling of ceilings or walls), we shall assume that the substrate will permit immediate installation of the goods delivered and that site measurements specified to us are correct.

Any costs resulting from defects in the substrate shall be at the expense of the principal. Special treatment of the substrate and measurement of rooms shall only be performed by us if such services are part of the contract and expressly mentioned in our order confirmation. All and any extra services shall be separately charged by us.

Additional costs due to incorrect specification of site measurements or of dates on the part of the principal shall be at his expense. On completion of special measures as well as on completion of the installation work, the principal shall have to confirm to the installer in charge that the work performed and the measurements of the finished surface laid are correct.

The provisions of the German Standard Building Contract Terms [VOB], Part B and Part C, shall be applicable unless the contractor is a consumer pursuant to § 13 of the German Civil Code [BGB].

Site measurements shall be calculated including thresholds and recesses according to dimensions in unfinished state. Mouldings and expansion gaps shall not be deducted. Areas that are to be left uninstalled, such as the bases of pillars, chimneys, etc., with a surface up to 0.5 m², shall not be deducted either.

7. Reservation of Title

All and any goods delivered (goods under reservation) shall remain our property until the purchase price and all other claims due to us as a result of the business relationship have been fully paid.

Pledging or transfer or ownership by way of security shall not be admissible without our consent. Any processing of goods under reservation shall take place on our behalf, free of charge, and without any

obligation to regard us as Manufacturer within the meaning of § 950. The purchaser shall assign to us co-title in the new goods in the proportion of the invoiced value of the goods under reservation to the other goods processed as at the time of processing. All and any new goods resulting from such processing shall be deemed goods under reservation.

If the goods delivered are combined with a movable item of goods in such a way that they become an essential component of another item of goods that is to be regarded as the main item, the purchaser shall hereby assign to us co-title in the new item on a quota basis. In such case he shall hereby assign to us all and any claims for remuneration that may arise against any third party, together with all subsidiary rights, in the amount of the value of the goods under reservation, and he shall authorise us to collect such claims, with the proviso of revocation. We do hereby accept such anticipatory assignment and authorisation.

The purchaser shall be permitted to resell and process such goods as set forth hereinabove only in the ordinary course of business, and only on condition that said claims do in fact devolve upon us. This shall include that the purchaser receives payment from his customer or makes the reservation that ownership shall not go to his customer before the same has fulfilled his obligations in terms of payment. The purchaser shall agree so with his sub-purchaser.

In the event of attachment, seizure, or any other action or intervention by a third party, the purchaser shall have to notify us immediately and completely.

In the event that the purchaser falls behind with payments, we shall be entitled, without fixing another deadline, to terminate the purchaser's right of title by unilateral declaration and claim return of the unprocessed material.

All and any of the purchaser's rights mentioned herein shall lapse in the event of discontinuation of payments and / or institution of insolvency proceedings. This shall not apply to the rights of the trustee in insolvency.

The assertion of the reservation of title through us shall require no cancellation, whereas the purchaser shall be obligated to promptly grant us any access so that we may make appropriate establishments and dispose of the goods under reservation.

If the value of the securities granted exceeds our claims, possibly reduced by down payments or instalments, by more than 20%, we shall be obligated to reassign title or release goods in the same measure, whichever we may choose.

On settlement of all our claims arising from the business relationship, ownership of the goods under reservation and all and any claims assigned to us shall devolve on the purchaser.

8. Conditions of Payment

Our invoices shall be issued under the date of shipment of goods or, in the case of orders for installation, upon completion of the work. Unless otherwise agreed, they shall be due for payment without any deduction within 30 days.

Any claims or performance in part shall be invoiced separately and shall each be payable individually, independently of the total scope of delivery or performance. Payments made on account shall be set against part deliveries according to the order in which such deliveries shall be made.

If any payments are deferred or received after maturity, we shall be entitled to charge interest as from the date of maturity in the amount of loan costs incurred by us. Otherwise the legal provisions pursuant to §§ 286 ff of the German Civil Code [BGB] shall apply in the event of any default in payment. Any further claims shall remain unaffected.

A right to set off shall only exist in the event of undisputed claims or for claims that have been conclusively determined by a court. In cases of justified deficiency claims, retention of payments shall only be admissible to such an extent as shall represent a reasonable relation to the actual defect of quality. Our sales representatives and agents shall not be entitled to collect bills unless they produce our written authorization to collect debts.

9. Data Protection

We shall be entitled, within the limits allowed by the German Data Protection Act, to process any information concerning the contractor with regard to or in connection with the business relationship, no matter whether such data have been received from the contractor himself or from any third party.

10. Place of Performance – Place of Jurisdiction – Applicable Law

D-83071 Stephanskirchen shall be the place of performance and jurisdiction regarding deliveries and payments (including legal action based on dishonoured cheques or bills of exchange) as well as all and any disputes that may arise between the parties hereto, if the contractor is a merchant or a legal entity under public law, or if he represents special funds under public law. We shall, however, also be entitled to sue the purchaser at his registered domicile.

The relations between the contracting parties shall be governed only and entirely by the law applicable in the Federal Republic of Germany, exclusive of the UN law on sales.

11. Final Provisions

Should any of the provisions herein be found to violate any statutory prohibition(s) or to be invalid for any other reason(s), this shall not affect the validity of the other provisions.

In lieu of such invalid provisions, if any, it shall be deemed agreed what would have been closest to the economic interest and to the presumed will of the contracting parties in accordance with the other terms and conditions of business. The same shall apply in the event of any gap(s) herein.

The contracting parties shall undertake to make a serious effort to contribute to the completion of substitute provisions to such effect.